

2025

SPECIFICATION GUIDE

VARIFORM[®]
by  Ply Gem



Vinyl Siding & Accessories



A leading manufacturer of
exterior building products
in North America

#1 windows

#1 vinyl siding
& accessories

#1 metal roofing
& wall systems

#1 turnkey stone
solutions





SIDING THAT WITHSTANDS

For more than 50 years, the Variform brand of vinyl siding has set the standard for quality, durability and versatility on any jobsite.

With a legacy built on trust, Variform delivers not only effortless style but also proven performance that stands the test of time.



**TRIED-AND-TRUE
SOLUTIONS FOR PROS**



**EFFORTLESS STYLE
FOR HOMES**



**EXCEPTIONAL VALUE
FOR ALL**

TABLE OF CONTENTS

INFORMATIONAL RESOURCES	6
VINYL SIDING	
HERITAGE CEDAR® HAND-SPLIT SHAKE	7
HERITAGE CEDAR® PERFECTION SHINGLE	8
HERITAGE CEDAR® ROUND CUT	10
CEDAR ACCESSORIES	11
CLIMAFORCE® HIGH PERFORMANCE	12
CLIMAFORCE® ACCESSORIES	13
VORTEX EXTREME™	16
CAMDEN POINTE®	18
AMERICAN HERALD®	19
ASHTON HEIGHTS®	21
CONTRACTOR'S CHOICE®	22
VICTORIA HARBOR®	24
BOARD & BATTEN	24
VINYL SOFFIT	
TRIVENT® HIGH PERFORMANCE SOFFIT	25
D5 PREMIUM SOFFIT	26
D5 STANDARD SOFFIT	26
T4 SOFFIT	27
BEADED SOFFIT & PORCH CEILING	28
T4 ECONOMY SOFFIT	29
D5 ECONOMY SOFFIT	30
VINYL ACCESSORIES	
BEADED SOFFIT ACCESSORIES	31
UNIVERSAL WOODGRAIN ACCESSORIES	32
VINYL ACCESSORIES	33
VINYL SKIRTING	
PROGUARD® SKIRTING	41
SKIRTING ACCESSORIES	42
APPLICATION TOOLS	
TOOLS	44

PLY GEM SHUTTERS & ACCESSORIES

STANDARD SHUTTERS	45
LOUVERED SHUTTERS	46
BOARD & BATTEN SHUTTERS	47
SHUTTER ACCESSORIES	50
DOOR SURROUNDS	53
MANTELS	55
MOUNTING BLOCKS	58
UTILITY VENTS	65
GABLE VENTS	68

PLY GEM PERFORMANCE METALS

ALUMINUM TRIM SHEET	73
ALUMINUM TRIM COIL	75
ALUMINUM SIDING	79
ALUMINUM SOFFIT	83
ALUMINUM FASCIA	91
ALUMINUM ACCESSORIES	95
ALUMINUM GUTTER COIL	100
ALUMINUM RAINWARE	102

PLY GEM GUTTER PROTECTION SYSTEMS

GUTTER PROTECTION SYSTEMS	123
-------------------------------------	-----

ROOFING ACCESSORIES

ROOFING ACCESSORIES	131
-------------------------------	-----

PLY GEM TRIM & MOULDING

BUILDREADY	138
DESIGNREADY	152

STANDARDS & CODES 155

PROPERTIES 156



[VARIFORM VINYL SIDING AND ACCESSORIES COLOR MATRIX](#)



[PLY GEM ACCESSORIES \(DESIGNER ACCENTS\) COLOR MATRIX](#)



[PLY GEM METAL \(PERFORMANCE METALS\) COLOR REFERENCE MATRIX](#)



Accessing Pro Academy Training Videos

Watch quick, user-friendly videos linked below to learn more about Variform products and installation techniques. You can access the videos by using the camera app on your smartphone or tablet to scan the QR codes below. Then click on the pop-up bar to open the video.

If you are accessing this page electronically and the video name is highlighted in blue, you can click on the name to watch the video. Once the video link opens, you can change the language and speed of the video by clicking on the setting gear in the bottom right corner.



[TRAINING HUB](#)

PRODUCT CODE/DESCRIPTION

560

HERITAGE CEDAR HAND-SPLIT SHAKE*

DESCRIPTION

- 58-1/8" w x 21-1/8" h
- Product Thickness: .100
- Exposure average: 9-3/8"
- Exposure length: 54-5/8"
- 7 Panels (1/2 sq.)/Ctn.
- 42.3 Lbs./Ctn.

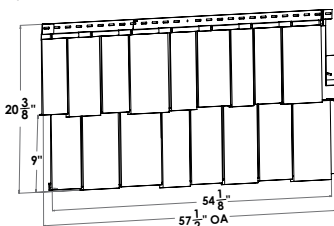

*Requires 7/8" pocket accessories and Universal Cedar Starter Strip #CPSSHD or #CDSS

**Note: Variegated accessories are not available for a Cabin Cedar and Cottage Gray. Use Briarwood accessories for Cabin Cedar and Flint accessories for Cottage Gray.

COLOR AVAILABILITY

STANDARD COLORS

Classic Cream
Dover White
Flint
Georgian Gray
Irish Thistle
Island Pearl
Natural Almond
Sandy Tan
Silver Mist
Spanish Olive

DARK COLOR

Stone Mtn. Clay

SHADED COLORS

Cabin Cedar
Cottage Gray

PREMIUM DARK COLORS

Bayou
Briarwood
Deep Brunswick
Pewter
Sagebrook
Sedona Red
Teak
Twilight Shadow
Urban Iron
Wedgewood

558

HERITAGE CEDAR HAND-SPLIT SHAKE OUTSIDE CORNER POST

DESCRIPTION

- 3-1/2" w x 38-1/2" h
- Pocket Depth: 1"
- 10 Pcs./Ctn.
- 13 Lbs./Ctn.

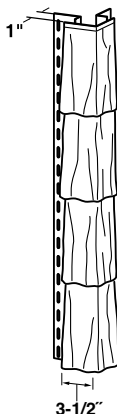

**Note: Variegated accessories are not available for a Cabin Cedar and Cottage Gray. Use Briarwood accessories for Cabin Cedar and Flint accessories for Cottage Gray.

**CEDAR
PANELS AND
ACCESSORIES**



**INSTALL CEDAR
PANELS**



**HOW TO REPLACE
A CEDAR PANEL**



HERITAGE CEDAR®

PRODUCT CODE/DESCRIPTION

556

HERITAGE CEDAR PERFECTION SHINGLE SIDING*

DESCRIPTION

- 54-5/8" w x 15-1/2" h
- Product Thickness: .100
- Exposure: Double 7"
- Exposure length: 51-7/8"
- 10 Panels [1/2 sq.]/Ctn.
- 48 Lbs./Ctn.

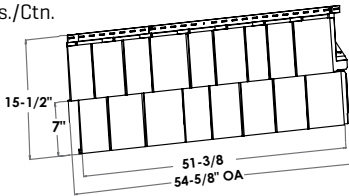

*Requires 7/8" pocket accessories and Universal Cedar Starter Strip #CPSSHD or #CDSS

**Note: Variegated accessories are not available for a Cabin Cedar and Cottage Gray.
Use Briarwood accessories for Cabin Cedar and Flint accessories for Cottage Gray.

COLOR AVAILABILITY

STANDARD COLORS

- Autumn Beige
- Classic Cream
- Dover White
- Flint
- Georgian Gray
- Hazelnut
- Irish Thistle
- Island Pearl
- Natural Almond
- Sandtone
- Sandy Tan
- Savannah Blue
- Silver Mist
- Spanish Olive

PREMIUM DARK COLORS

- Bayou
- Briarwood
- Deep Brunswick
- Mediterranean
- Palm
- Old Dublin
- Pewter
- Sagebrook
- Sedona Red
- Teak
- Twilight Shadow
- Urban Iron
- Wedgewood

DARK COLOR

- Stone Mtn. Clay

SHADED COLORS

- Cabin Cedar
- Cottage Gray

557

HERITAGE CEDAR PERFECTION SHINGLE SIDING OUTSIDE CORNER POST

DESCRIPTION

- 3-1/2" w x 28-1/8" h
- Pocket Depth: 7/8"
- 10 Pcs./Ctn.
- 15.7 Lbs./Ctn.

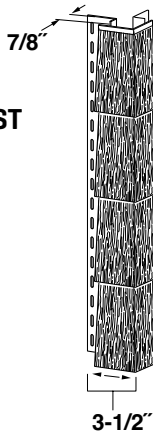

PRODUCT CODE/DESCRIPTION

570

HERITAGE CEDAR PERFECTION TRIPLE 5" SHINGLE

DESCRIPTION

- 69-1/2" Length
- Nominal Thickness: .090"
- Exposure Triple 5"
- Exposure length: 63"
- 7 Panels [.46 sq.]/Ctn.
- 35 Lbs./Ctn.

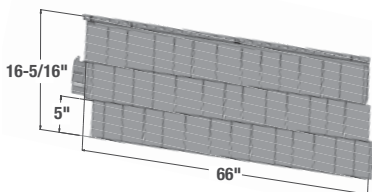

Note: 3/4" minimum vinyl siding accessories are required for installation.

COLOR AVAILABILITY

STANDARD COLORS

- Autumn Beige
- Classic Cream
- Dover White
- Georgian Gray
- Island Pearl
- Natural Almond
- Sandtone
- Sandy Tan
- Savannah Blue
- Silver Mist
- Spanish Olive

DARK COLORS

- Flint
- Hazelnut
- Irish Thistle
- Stone Mtn. Clay

PREMIUM DARK COLORS

- Bayou
- Briarwood
- Mediterranean
- Palm
- Pewter
- Sagebrook
- Sedona Red
- Teak
- Twilight Shadow
- Wedgewood

SHADED COLORS

- Cabin Cedar
- Cottage Gray

571

HERITAGE CEDAR PERFECTION CORNER POST TRIPLE 5"

DESCRIPTION

- 3-1/2" width x 31" height
- Pocket Depth: 1"
- 10 Pcs./Ctn.
- 19.5 Lbs./Ctn.

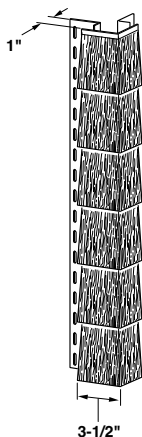

STANDARD COLORS

- Autumn Beige
- Classic Cream
- Dover White
- Flint
- Georgian Gray
- Hazelnut
- Irish Thistle
- Island Pearl
- Natural Almond
- Sandtone
- Sandy Tan
- Savannah Blue
- Silver Mist
- Spanish Olive
- Stone Mtn. Clay

PREMIUM DARK COLORS

- Bayou
- Briarwood
- Mediterranean
- Palm
- Pewter
- Sagebrook
- Sedona Red
- Teak
- Twilight Shadow
- Wedgewood

SHADED COLORS

- Cabin Cedar
- Cottage Gray

HERITAGE CEDAR®

PRODUCT CODE/DESCRIPTION

559

HERITAGE CEDAR ROUND CUT SIDING*

DESCRIPTION

- 51-3/4" width x 16-3/8" height
- Exposure length: 48"
- Product Thickness: .080"
- 12 Panels [1/2 Sqs.]/Ctn.
- 38.68 Lbs./Ctn.

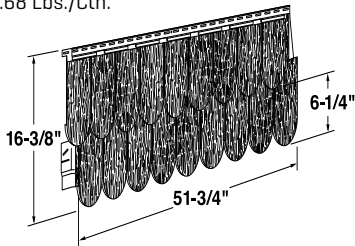

COLOR AVAILABILITY

STANDARD COLORS

Autumn Beige
Classic Cream
Dover White
Georgian Gray
Island Pearl
Natural Almond

DARK COLORS

Flint
Sandy Tan
Stone Mtn. Clay

*Requires 3/4" pocket accessories and Universal Cedar Starter Strip #CDSSHD or #CDSS

**CEDAR PANELS -
LAST PANEL IN
EAVE & GABLE**



PRODUCT CODE/DESCRIPTION

COLOR AVAILABILITY

CPSSHD 00

Mill Finish

UNIVERSAL CEDAR STARTER STRIP GALVANIZED (STEEL)

DESCRIPTION

- Heavy duty steel starter strip
- For use with Heritage Cedar Panels
- 10' x 3-1/2"
- 25 Pcs./Ctn.
- 49 Lbs./Ctn.

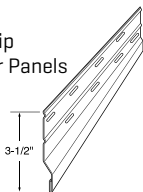

CDSS 00

UNIVERSAL CEDAR STARTER STRIP (ALUMINUM)

DESCRIPTION

- Aluminum starter strip
- For use with Heritage Cedar Panels
- 10' x 2-1/2"
- 50 Pcs./Ctn.
- 32 Lbs./Ctn.

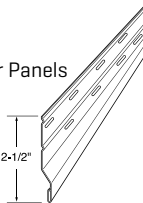

PRODUCT CODE/DESCRIPTION

108

**DOUBLE 6"
TRADITIONAL**

DESCRIPTION

- 12' 6" Panel
- Finish: Split Blrch
- Overall Thickness: of 1-1/8"
- 8 Panels [1 sq.]/Ctn.
- 62 Lbs./Ctn.

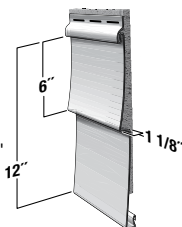

COLOR AVAILABILITY

**STANDARD
COLORS**

Classic Cream
Dover White
Georgian Gray
Island Pearl
Natural Almond
Rich Mocha
Sandy Tan
Silver Mist

DARK COLORS

Flint
Irish Thistle
Stone Mtn. Clay

**PREMIUM DARK
COLORS**

Briarwood
Pewter
Sagebrook
Wedgewood

112

SINGLE 7"

DESCRIPTION

- 12' 3" Panel
- Finish: Split Blrch
- Overall Thickness: of 1-1/8"
- 14 Panels [1 sq.]/Ctn.
- 68 Lbs./Ctn.

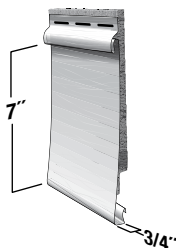

**FOAM
INSULATED
SIDING
OPTIONS**



**INSTALLING
VINYL SIDING
PANELS**



PRODUCT CODE/DESCRIPTION

352

OUTSIDE CORNER POST

DESCRIPTION

- 12' 0" Length
- Finish: Matte
- For use with Climaforce®
- 10 Pcs./Ctn.
- 53.88 Lbs./Ctn.

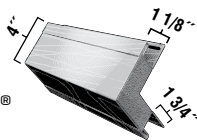

COLOR AVAILABILITY

STANDARD COLORS

Classic Cream
 Dover White
 Georgian Gray
 Island Pearl
 Natural Almond
 Rich Mocha
 Sandy Tan
 Silver Mist

DARK COLORS

Flint*
 Irish Thistle*
 Stone Mtn. Clay*

PREMIUM DARK COLORS

Briarwood
 Pewter
 Sagebrook
 Wedgewood

* Premium color upcharge applies

359

INSIDE CORNER POST

DESCRIPTION

- 12' 0" Length
- Finish: Matte
- For use with Climaforce®
- 10 Pcs./Ctn.
- 27.54 Lbs./Ctn.

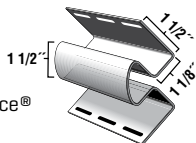

**FOAM-BACKED
 SIDING OPTIONS**



PRODUCT CODE/DESCRIPTION

COLOR AVAILABILITY

393

Mill Finish

NEW CONSTRUCTION LINEAL STARTER

DESCRIPTION

- 10' 0" Length
- For use with window & door lineal #300
- 40 Pcs./Ctn.
- 45.22 Lbs./Ctn.

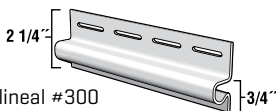

365

2-PIECE WIDE CROWN MOLDING

DESCRIPTION

- 12' 6" Length
- Finish: Low-gloss Pebble
- For use with Extend Crown Back Plate #409
- 24 Pcs./Ctn.
- 33.71 Lbs./Ctn.

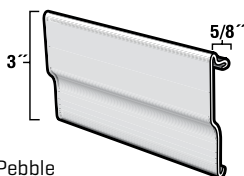

STANDARD COLORS

Classic Cream
Dover White
Georgian Gray
Island Pearl
Natural Almond
Sandy Tan
Silver Mist

DARK COLORS

Flint
Irish Thistle
Stone Mtn. Clay

409

Dover White

EXTENDED CROWN BACK PLATE

DESCRIPTION

- 12' 6" Length
- Finish: Low-gloss Pebble
- For use with 2-Piece Wide Crown Molding # 365
- 24 Pcs./Ctn.
- 60.90 Lbs./Ctn.

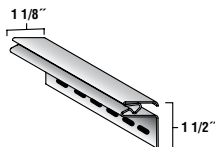

PRODUCT CODE/DESCRIPTION

40023

1-1/4" J-CHANNEL

DESCRIPTION

- For use with Climaforce®
- 12' 6" Length
- Finish: Low-gloss Pebble
- 40 Pcs./Ctn.
- 53 Lbs./Ctn.

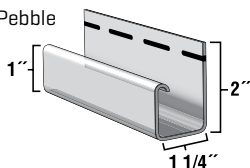

COLOR AVAILABILITY

STANDARD

- COLORS**
 Classic Cream
 Dover White
 Georgian Gray
 Island Pearl
 Natural Almond
 Rich Mocha
 Sandy Tan
 Silver Mist

DARK COLORS

- Flint
 Irish Thistle
 Stone Mtn. Clay
PREMIUM DARK
COLORS
 Briarwood
 Pewter
 Wedgewood
 Sagebrook

396

DUAL UNDERSILL TRIM

DESCRIPTION

- 12' 6" Length
- Finish: Low-gloss Pebble
- For use with Climaforce™
- 24 Pcs./Ctn.
- 45.16 Lbs./Ctn.

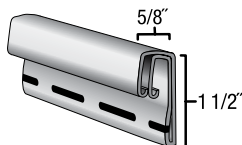

STANDARD

- COLORS**
 Classic Cream
 Dover White
 Georgian Gray
 Island Pearl
 Natural Almond
 Sandy Tan
 Silver Mist

DARK COLORS

- Flint
 Irish Thistle
 Stone Mtn. Clay

505

STARTER STRIP

DESCRIPTION

- 12' 6" Length
- Finish: Low-gloss Pebble
- For use with Climaforce®
- 24 Pcs./Ctn.
- 42 Lbs./Ctn.

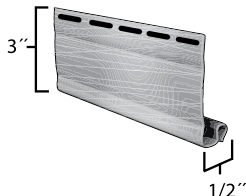

PRODUCT CODE/DESCRIPTION

272

DOUBLE 4" TRADITIONAL

DESCRIPTION

- 12' 6" Panel
- Double 4 Traditional Lap
- Product Thickness: .046"
- 24 Panels [2 Sqs.]/Ctn.
- 118.05 Lbs./Ctn.

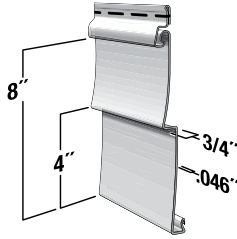

COLOR AVAILABILITY

STANDARD COLORS

- Autumn Beige
- Classic Cream
- Dover White
- Georgian Gray
- Heritage Linen
- Island Pearl
- Natural Almond
- Rich Mocha
- Sandtone
- Sandy Tan
- Savannah Blue
- Silver Mist
- Spanish Olive

DARK COLORS

- Flint
- Hazelnut
- Irish Thistle
- Stone Mtn. Clay

PREMIUM DARK COLORS

- Bayou
- Briarwood
- Deep Brunswick
- Mediterranean

- Palm
- Old Dublin
- Pewter
- Sagebrook
- Sedona Red
- Teak
- Twilight Shadow
- Urban Iron
- Wedgewood

274

DOUBLE 5" TRADITIONAL

DESCRIPTION

- 12' 0" Panel
- Double 5 Traditional Lap
- Product Thickness: .046"
- 20 Panels [2 Sqs.]/Ctn.
- 108.64 Lbs./Ctn.

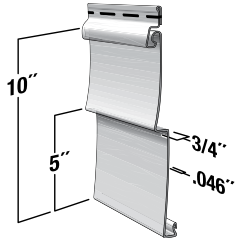

STANDARD COLORS

- Autumn Beige
- Classic Cream
- Dover White
- Georgian Gray
- Heritage Linen
- Island Pearl
- Natural Almond
- Rich Mocha
- Sandtone
- Sandy Tan
- Savannah Blue
- Silver Mist
- Spanish Olive

DARK COLORS

- Flint
- Hazelnut
- Irish Thistle
- Stone Mtn. Clay

PREMIUM DARK COLORS

- Briarwood
- Pewter
- Sagebrook
- Wedgewood

PRODUCT CODE/DESCRIPTION

276

DOUBLE 4.5" DUTCH LAP

DESCRIPTION

- 12' 1" Panel
- Double 4.5 Dutch Lap
- Product Thickness: .046"
- 22 Panels [2 Sqs.]/Ctn.
- 113.96 Lbs./Ctn.

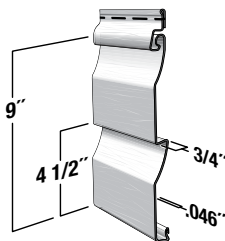

COLOR AVAILABILITY

STANDARD COLORS

- Autumn Beige
- Classic Cream
- Dover White
- Georgian Gray
- Heritage Linen
- Island Pearl
- Natural Almond
- Rich Mocha
- Sandtone
- Sandy Tan
- Savannah Blue
- Silver Mist
- Spanish Olive

DARK COLORS

- Flint
- Hazelnut
- Irish Thistle
- Stone Mtn. Clay

PREMIUM DARK COLORS

- Bayou
- Briarwood
- Deep Brunswick
- Mediterranean

- Palm
- Old Dublin
- Pewter
- Sagebrook
- Sedona Red
- Teak
- Twilight Shadow
- Urban Iron
- Wedgewood

272-16

DOUBLE 4" TRADITIONAL

DESCRIPTION

- 16' 8" Panel
- Double 4 Traditional Lap
- Product Thickness: .046"
- 18 Panels [2 Sqs.]/Ctn.
- 122.05 Lbs./Ctn.

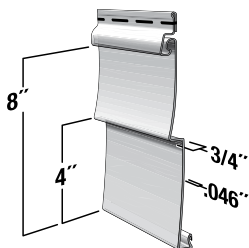

STANDARD COLORS

- Dover White
- Georgian Gray
- Island Pearl
- Natural Almond
- Sandy Tan
- Savannah Blue
- Silver Mist
- Spanish Olive

DARK COLORS

- Flint
- Hazelnut
- Irish Thistle
- Stone Mtn. Clay

PREMIUM DARK COLORS

- Bayou
- Briarwood
- Mediterranean
- Palm
- Pewter
- Sagebrook
- Teak
- Twilight Shadow
- Wedgewood

276-16

DOUBLE 4.5" DUTCH LAP

DESCRIPTION

- 16' 8" Panel
- Double 4.5 Dutch Lap
- Product Thickness: .046"
- 16 Panels [2 Sqs.]/Ctn.
- 117.96 Lbs./Ctn.

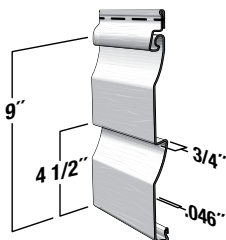

STANDARD COLORS

- Dover White
- Georgian Gray
- Island Pearl
- Natural Almond
- Sandy Tan
- Savannah Blue
- Silver Mist
- Spanish Olive

DARK COLORS

- Flint
- Hazelnut
- Irish Thistle
- Stone Mtn. Clay

PREMIUM DARK COLORS

- Bayou
- Briarwood
- Mediterranean
- Palm
- Pewter
- Sagebrook
- Teak
- Twilight Shadow
- Wedgewood

PRODUCT CODE/DESCRIPTION

195

DOUBLE 4" TRADITIONAL

DESCRIPTION

- 12' 6" Panel
- Double 4 Traditional Lap
- Product Thickness: .044"
- 24 Panels [2 Sqs.]/Ctn.
- 108.86 Lbs./Ctn.

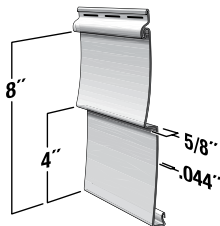

COLOR AVAILABILITY

STANDARD COLORS

- Autumn Beige
- Classic Cream
- Dover White
- Georgian Gray
- Heritage Linen
- Island Pearl
- Natural Almond
- Rich Mocha
- Sandtone
- Sandy Tan
- Silver Mist
- Spanish Olive

PREMIUM DARK COLORS

- Bayou
- Briarwood
- Deep Brunswick
- Mediterranean
- Palm
- Old Dublin
- Pewter
- Sagebrook
- Sedona Red
- Teak
- Twilight Shadow
- Urban Iron
- Wedgewood

196

DOUBLE 4" DUTCH LAP

DESCRIPTION

- 12' 6" Panel
- Double 4 Dutch Lap
- Product Thickness: .044"
- 24 Panels [2 Sqs.]/Ctn.
- 110.38 Lbs./Ctn.

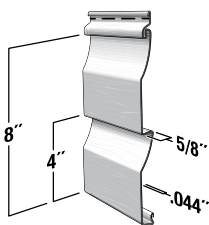

DARK COLORS

- Flint
- Hazelnut
- Irish Thistle
- Stone Mtn. Clay

197

DOUBLE 5" TRADITIONAL

DESCRIPTION

- 12' 0" Panel
- Double 5 Traditional Lap
- Product Thickness: .044"
- 20 Panels [2 Sqs.]/Ctn.
- 101.48 Lbs./Ctn.

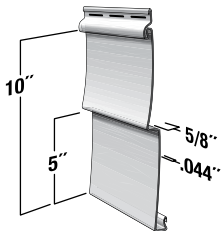

STANDARD COLORS

- Autumn Beige
- Classic Cream
- Dover White
- Georgian Gray
- Heritage Linen
- Island Pearl
- Natural Almond
- Rich Mocha
- Sandtone
- Sandy Tan
- Silver Mist
- Spanish Olive

DARK COLORS

- Flint
 - Hazelnut
 - Irish Thistle
 - Stone Mtn. Clay
- PREMIUM DARK COLORS**
- Briarwood
 - Pewter
 - Sagebrook
 - Wedgewood

198

DOUBLE 5" DUTCH LAP

DESCRIPTION

- 12' 0" Panel
- Double 5 Dutch Lap
- Product Thickness: .044"
- 20 Panels [2 Sqs.]/Ctn.
- 102.18 Lbs./Ctn.

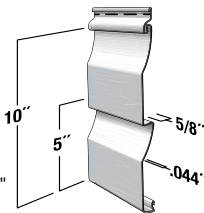

PRODUCT CODE/DESCRIPTION

36550

DOUBLE 4" TRADITIONAL

DESCRIPTION

- 12' 6" Panel
- Horizontal clapboard
- Deep Cedar woodgrain pattern
- Product Thickness: .044"
- 24 Panels [2 Sqs.]/Ctn.
- 95.06 Lbs./Ctn.

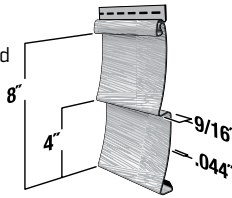

COLOR AVAILABILITY

STANDARD COLORS

- Dover White
- Georgian Gray
- Heritage Linen
- Natural Almond
- Rich Mocha
- Sandtone
- Sandy Tan
- Spanish Olive

DARK COLORS

- Flint
- Irish Thistle
- Stone Mtn. Clay

PREMIUM DARK COLORS

- Bayou
- Briarwood
- Deep Brunswick
- Mediterranean Palm
- Old Dublin
- Pewter
- Sagebrook
- Sedona Red
- Teak
- Twilight Shadow
- Urban Iron
- Wedgewood

36553

DOUBLE 4" DUTCH LAP

DESCRIPTION

- 12' 6" Panel
- Horizontal Dutch Lap
- Deep Cedar woodgrain pattern
- Product Thickness: .044"
- 24 Panels [2 Sqs.]/Ctn.
- 95.16 Lbs./Ctn.

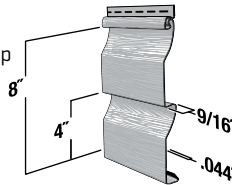

PRODUCT CODE/DESCRIPTION

36552

DOUBLE 5" TRADITIONAL

DESCRIPTION

- 12'0" Panel
- Horizontal clapboard
- Deep Cedar woodgrain pattern
- Product Thickness: .044"
- 20 Panels [2 Sqs.]/Ctn.
- 89.34 Lbs./Ctn.

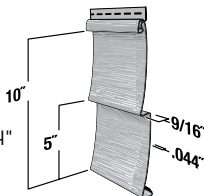

COLOR AVAILABILITY

STANDARD COLORS

- Dover White
- Georgian Gray
- Heritage Linen
- Natural Almond
- Rich Mocha
- Sandtone
- Sandy Tan
- Spanish Olive

DARK COLORS

- Flint
- Irish Thistle
- Stone Mtn. Clay

PREMIUM DARK COLORS

- Briarwood
- Pewter
- Sagebrook
- Wedgewood

36554

DOUBLE 5" DUTCH LAP

DESCRIPTION

- 12'0" Panel
- Horizontal Dutch Lap
- Deep Cedar woodgrain pattern
- Product Thickness: .044"
- 20 Panels [2 Sqs.]/Ctn.
- 82.78 Lbs./Ctn.

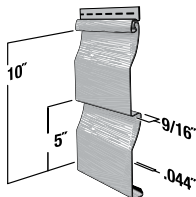

PRODUCT CODE/DESCRIPTION

117

DOUBLE 4" TRADITIONAL

DESCRIPTION

- 12' 6" Panel
- Double 4 Traditional Lap
- Product Thickness: .042"
- 24 Panels [2 Sqs.]/Ctn.
- 94.76 Lbs./Ctn.

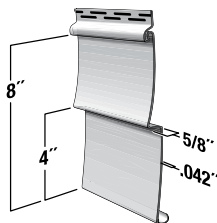

COLOR AVAILABILITY

STANDARD COLORS

- Autumn Beige
- Classic Cream
- Dover White
- Georgian Gray
- Heritage Linen
- Island Pearl
- Natural Almond
- Rich Mocha
- Sandtone
- Sandy Tan
- Savannah Blue
- Silver Mist
- Spanish Olive

DARK COLORS

- Flint
- Hazelnut
- Irish Thistle
- Stone Mtn. Clay

PREMIUM DARK COLORS

- Briarwood
- Old Dublin
- Pewter
- Sagebrook
- Teak
- Twilight Shadow
- Wedgewood

118

DOUBLE 4.5" DUTCH LAP

DESCRIPTION

- 12' 1" Panel
- Double 4.5 Dutch Lap
- Product Thickness: .042"
- 22 Panels [2 Sqs.]/Ctn.
- 90.92 Lbs./Ctn.

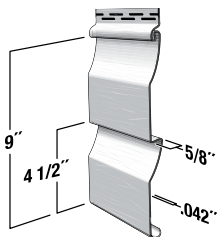

175

DOUBLE 5" TRADITIONAL

DESCRIPTION

- 12' 0" Panel
- Double 5 Traditional Lap
- Product Thickness: .042"
- 20 Panels [2 Sqs.]/Ctn.
- 91.20 Lbs./Ctn.

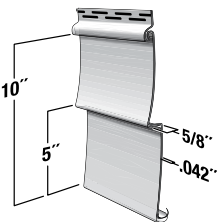

STANDARD COLORS

- Autumn Beige
- Classic Cream
- Dover White
- Georgian Gray
- Heritage Linen
- Island Pearl
- Natural Almond
- Rich Mocha
- Sandtone
- Sandy Tan
- Savannah Blue
- Silver Mist
- Spanish Olive

DARK COLORS

- Flint
- Hazelnut
- Irish Thistle
- Stone Mtn. Clay

PREMIUM DARK COLORS

- Briarwood
- Pewter
- Sagebrook
- Wedgewood

PRODUCT CODE/DESCRIPTION

COLOR AVAILABILITY

125

DOUBLE 4" TRADITIONAL

DESCRIPTION

- 12' 6" Panel
- Double 4 Traditional Lap
- Product Thickness: .040"
- 24 Panels
[2 Sqs.]/Ctn.
- 86.42 Lbs./Ctn.

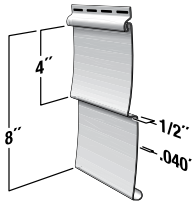

STANDARD COLORS

- Dover White
- Autumn Beige
- Classic Cream
- Georgian Gray
- Heritage Linen
- Island Pearl
- Natural Almond
- Rich Mocha
- Sandtone
- Sandy Tan
- Savannah Blue
- Silver Mist
- Spanish Olive

DARK COLORS

- Flint
- Irish Thistle
- Southern
- Cypress
- Stone Mtn. Clay

110

DOUBLE 4.5" DUTCH LAP

DESCRIPTION

- 12' 1" Panel
- Double 4.5 Dutch Lap
- Product Thickness: .040"
- 22 Panels
[2 Sqs.]/Ctn.
- 84.26 Lbs./Ctn.

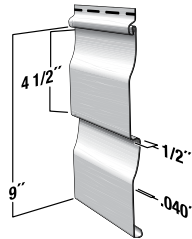

135

DOUBLE 5" TRADITIONAL

DESCRIPTION

- 12' 0" Panel
- Double 5 Traditional Lap
- Product Thickness: .040"
- 20 Panels
[2 Sqs.]/Ctn.
- 81.84 Lbs./Ctn.

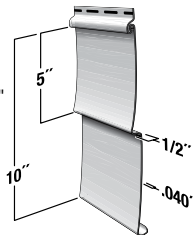

139

DOUBLE 5" DUTCH LAP

DESCRIPTION

- 12' 0" Panel
- Double 5 Dutch Lap
- Product Thickness: .040"
- 20 Panels
[2 Sqs.]/Ctn.
- 81.90 Lbs./Ctn.

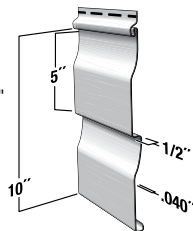

PRODUCT CODE/DESCRIPTION

169

TRIPLE 3" TRADITIONAL

DESCRIPTION

- 12' 1" Panel
- Triple 3 Traditional Lap
- Product Thickness: .040"
- 22 Panels [2 Sqs.]/Ctn.
- 86.68 Lbs./Ctn.

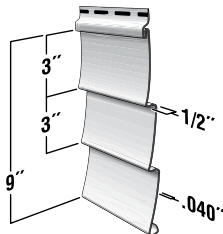

COLOR AVAILABILITY

STANDARD COLORS

- Autumn Beige
- Classic Cream
- Dover White
- Georgian Gray
- Heritage Linen
- Island Pearl
- Natural Almond
- Rich Mocha
- Sandtone
- Sandy Tan
- Savannah Blue
- Silver Mist
- Spanish Olive

DARK COLORS

- Flint
- Irish Thistle
- Southern Cypress
- Stone Mtn. Clay

VICTORIA HARBOR® / BOARD & BATTEN

PRODUCT CODE/DESCRIPTION

200

VICTORIA HARBOR® FULL BEADED SIDING

DESCRIPTION

- 12' 4" Panel
- 6.5 beaded lap
- Product Thickness: .044"
- 15 Panels [1 sq.]/Ctn.
- 60.09 Lbs./Ctn.

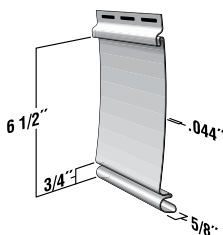

Use of 1WAP10 Aluminum Starter Strip recommended.

COLOR AVAILABILITY

STANDARD COLORS

- Autumn Beige
- Classic Cream
- Dover White
- Georgian Gray
- Heritage Linen
- Island Pearl
- Natural Almond
- Sandy Tan
- Savannah Blue
- Silver Mist
- Spanish Olive

DARK COLORS

- Flint
- Irish Thistle
- Stone Mtn. Clay

199

7" BOARD & BATTEN

DESCRIPTION

- 10' 0" Panel
- Vertical board & batten
- 7" Panel exposure
- Woodgrain pattern
- Product Thickness: .048"
- 5/8" J-Channel recommended
- 17 Panels [1 sq.]/Ctn.
- 53.90 Lbs./Ctn.

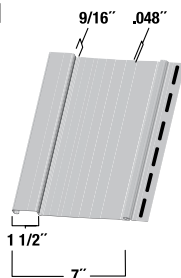

STANDARD COLORS

- Dover White
- Georgian Gray
- Heritage Linen
- Island Pearl
- Natural Almond
- Sandy Tan
- Savannah Blue
- Silver Mist
- Spanish Olive

DARK COLORS

- Flint
- Irish Thistle
- Stone Mtn. Clay

PREMIUM DARK COLORS

- Bayou
- Briarwood
- Deep Brunswick
- Mediterranean
- Palm
- Old Dublin
- Pewter
- Sagebrook
- Sedona Red
- Teak
- Twilight Shadow
- Wedgewood

VERTICAL SIDING OPTIONS



INSTALL HORIZONTAL BEADED SIDING



INSTALLING VERTICAL SIDING



PRODUCT CODE/DESCRIPTION

COLOR AVAILABILITY

133

TRIVENT HIGH PERFORMANCE SOLID SOFFIT

DESCRIPTION

- 12' 0" Length
- Product Thickness: .044"
- Finish: Matte
- Vertical application option
- 20 Panels [2 sq.]/Ctn.
- 121 Lbs./Ctn.

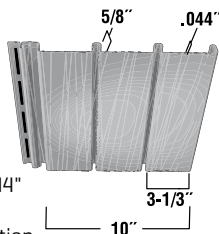

STANDARD

COLORS

- Dover White
- Heritage Linen
- Natural Almond

DARK COLORS

- Musket Brown
- Stone Mtn. Clay

PREMIUM DARK COLORS

- Briarwood
- Pewter

134

TRIVENT HIGH PERFORMANCE SOLID SOFFIT WITH X-TRA™ VENT

DESCRIPTION

- 12' 0" Panel
- 9.19 Sq. In./Sq. Ft. ventilation
- Product Thickness: .044"
- Finish: Matte
- 20 Panels [2 sq.]/Ctn.
- 122 Lbs./Ctn.

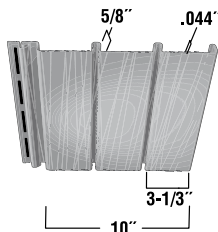

*Vented cannot be used as vertical siding

408

5/8" F-CHANNEL

DESCRIPTION

- 12' 6" Panel
- 24 Pcs./Ctn.
- 20 Panels [2 sq.]/Ctn.
- 40 Lbs./Ctn.
- 121 Lbs./Ctn.

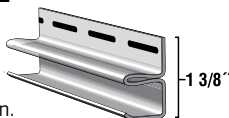

STANDARD

COLORS

- Dover White
- Heritage Linen
- Natural Almond

DARK COLORS

- Musket Brown
- Stone Mtn. Clay

PREMIUM DARK COLORS

- Briarwood

INSTALLING VINYL SOFFITS



D5 SOFFIT

PRODUCT CODE/DESCRIPTION

140

DOUBLE 5" PREMIUM SOLID

DESCRIPTION

- 12' 0" Panel
- Double 5 premium soffit
- Product Thickness: .044"
- Finish: Woodgrain
- 20 Panels [2 Sqs.]/Ctn.
- 94.50 Lbs./Ctn.

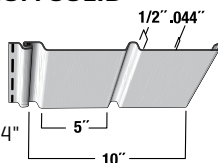

COLOR AVAILABILITY

STANDARD COLORS

Dover White
Island Pearl
Natural Almond
Rich Mocha
Sandy Tan
Savannah Blue
Silver Mist

DARK COLORS

Stone Mtn. Clay

141

DOUBLE 5" PREMIUM SOFFIT VENT*

DESCRIPTION

- 12' 0" Panel
- 6.2 Sq. In./Sq. Ft. ventilation
- Product Thickness: .044"
- Finish: Woodgrain
- 20 Panels [2 Sqs.]/Ctn.
- 89.14 Lbs./Ctn.

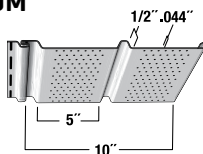

*Cannot be used as vertical siding

144

DOUBLE 5" STANDARD SOLID*

DESCRIPTION

- 12' 0" Panel
- Double 5" soffit
- Product Thickness: .040"
- Finish: Woodgrain
- 20 Panels [2 Sqs.]/Ctn.
- 86.64 Lbs./Ctn.

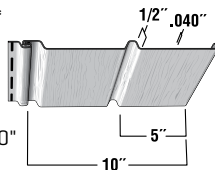
**STANDARD COLORS**

Autumn Beige
Classic Cream
Dover White
Georgian Gray
Heritage Linen
Island Pearl
Natural Almond
Sandy Tan
Silver Mist
Spanish Olive

DARK COLORS

Flint
Stone Mtn. Clay

*Cannot be used as vertical siding

145

DOUBLE 5" STANDARD VENT*

DESCRIPTION

- 12' 0" Panel
- 6.2 Sq. In./Sq. Ft. ventilation
- Product Thickness: .040"
- Finish: Woodgrain
- 20 Panels [2 Sqs.]/Ctn.
- 81.78 Lbs./Ctn.

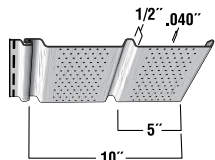

*Cannot be used as vertical siding

PRODUCT CODE/DESCRIPTION

COLOR AVAILABILITY

230

TRIPLE 4" SOLID

DESCRIPTION

- 12' 0" Panel
- Triple 4 vertical design
- Product Thickness: .038"
- Vertical application option
- Pebble finish
- 16 Panels [1.92 Sqs.]/Ctn.
- 80.62 Lbs./Ctn.

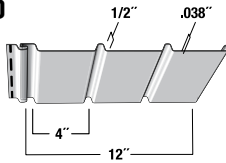

[*Black and Musket Brown colors not warranted for sidewall use.]

STANDARD COLORS

- Autumn Beige
- Classic Cream
- Dover White
- Georgian Gray
- Heritage Linen
- Island Pearl
- Natural Almond
- Rich Mocha
- Sandtone
- Sandy Tan
- Savannah Blue
- Silver Mist

DARK COLORS

- *Black
- Flint
- *Musket Brown
- Stone Mtn. Clay

232

TRIPLE 4" FULL VENT*

DESCRIPTION

- 12' 0" Panel
- 5.867 Sq. In./Sq. Ft. ventilation
- Product Thickness: .038"
- Round hole venting
- Pebble finish
- 16 Panels [1.92 Sqs.]/Ctn.
- 78.48 Lbs./Ctn.

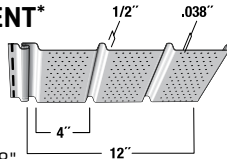

*Cannot be used as vertical siding

STANDARD COLORS

- Dover White
- Natural Almond
- Sandy Tan

DARK COLORS

- Black
- Musket Brown
- Stone Mtn. Clay

231

TRIPLE 4" CENTER VENT*

DESCRIPTION

- 12' 0" Panel
- 1.96 Sq. In./Sq. Ft. ventilation
- Product Thickness: .038"
- Round hole venting
- Pebble finish
- 16 Panels [1.92 Sqs.]/Ctn.
- 79.90 Lbs./Ctn.

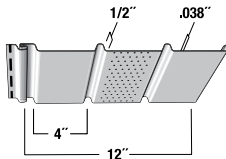

*Cannot be used as vertical siding

BEADED SOFFIT & PORCH CEILING

PRODUCT CODE/DESCRIPTION

157

BEADED SOLID

DESCRIPTION

- 12' 0" Panel
- Product Thickness: .040"
- 3/8" accessories recommended
- Vertical application option
- Pebble finish
- 28 Panels [2 sq.]/Ctn.
- 114.61 Lbs./Ctn.

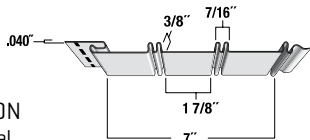

COLOR AVAILABILITY

STANDARD COLORS

- Dover White
- Heritage Linen
- Island Pearl
- Natural Almond
- Rich Mocha
- Sandy Tan
- Savannah Blue

DARK COLORS

- Stone Mtn. Clay

158

BEADED VENT*

DESCRIPTION

- 12' 0" Panel
- Hidden vent
- 2.66 Sq. In./Sq. Ft. ventilation
- 3/8" accessories recommended
- Product Thickness: .040"
- Pebble finish
- 28 Panels [2 sq.]/Ctn.
- 113.56 Lbs./Ctn.

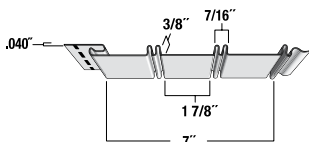

*Cannot be used as vertical siding

SOFFIT OPTIONS



INSTALLING PORCH
CEILINGS/BEADED SOFFIT



PRODUCT CODE/DESCRIPTION

COLOR AVAILABILITY

2309216

TRIPLE 4" SOLID*

DESCRIPTION

- 12' 0" Panel
- Triple 4 vertical design
- Product Thickness: .038"
- Vertical application option
- Pebble finish
- 16 Panels [1.92 Sqs.]/Ctn.
- 80.62 Lbs./Ctn.

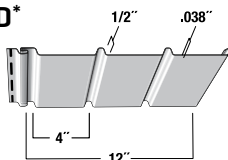

STANDARD COLORS
White

*Not an exact color match to Variform and Dover White color soffit.

*Cannot be used as vertical siding

2319216

TRIPLE 4" CENTER VENT*

DESCRIPTION

- 12' 0" Panel
- 1.96 Sq. In./Sq. Ft. ventilation
- Product Thickness: .038"
- Round hole venting
- Pebble finish
- 16 Panels [1.92 Sqs.]/Ctn.
- 79.90 Lbs./Ctn.

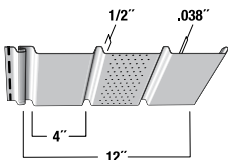

*Cannot be used as vertical siding

2329216

TRIPLE 4" FULL VENT*

DESCRIPTION

- 12' 0" Panel
- 5.867 Sq. In./Sq. Ft. ventilation
- Product Thickness: .038"
- Round hole venting
- Pebble finish
- 16 Panels [1.92 Sqs.]/Ctn.
- 78.48 Lbs./Ctn.

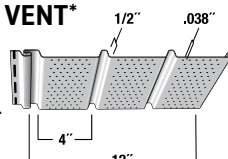

*Cannot be intermixed with standard white soffits.

ECONOMY SOFFIT

PRODUCT CODE/DESCRIPTION

1449216

DOUBLE 5" STANDARD SOLID*

DESCRIPTION

- 12' 0" Panel
- Double 5" Soffit
- Product Thickness: .040"
- Finish: Woodgrain
- 20 Panels [2 Sqs.]/Ctn.
- 86.64 Lbs./Ctn.

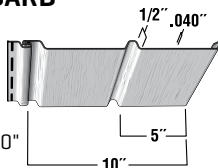

*Cannot be used as vertical siding

COLOR AVAILABILITY

STANDARD

COLORS

White

1459216

DOUBLE 5" SOFFIT VENT*

DESCRIPTION

- 12' 0" Panel
- 6.2 Sq. In./
Sq. Ft. ventilation
- Product Thickness: .044"
- Finish: Woodgrain
- 20 Panels [2 Sqs.]/Ctn.
- 89.14 Lbs./Ctn.

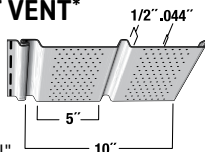

*Cannot be used as vertical siding

BEADED SOFFIT ACCESSORIES

PRODUCT CODE/DESCRIPTION

304

3/8" J-CHANNEL

DESCRIPTION

- 12' 6" Length
- Finish: Low-gloss Pebble
- For use with Beaded Soffit
- 40 Pcs./Ctn.
- 42.78 Lbs./Ctn.

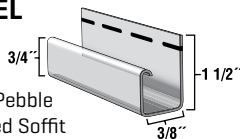

COLOR AVAILABILITY

STANDARD COLORS

- Dover White
- Heritage Linen
- Island Pearl
- Natural Almond
- Rich Mocha
- Sandy Tan
- Savannah Blue

DARK COLOR

- Stone Mtn. Clay

UNIVERSAL WOODGRAIN ACCESSORIES

PRODUCT CODE/DESCRIPTION

40022

3" OUTSIDE CORNER POST

DESCRIPTION

- 10' 0" Length
- Finish: Woodgrain
- 10 Pcs./Ctn.
- 37 Lbs./Ctn.

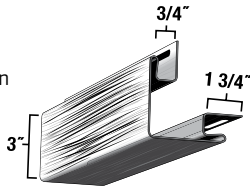

† Solid match for Cottage Gray Shingle Siding.

COLOR AVAILABILITY

STANDARD COLORS

- Autumn Beige
- Classic Cream
- Dover White
- Georgian Gray†
- Heritage Linen
- Island Pearl
- Natural Almond
- Rich Mocha
- Sandtone
- Sandy Tan
- Savannah Blue
- Silver Mist
- Spanish Olive

DARK COLORS

- Flint
- Hazelnut
- Irish Thistle
- Southern Cypress
- Stone Mtn. Clay

40020

4"X 3/4" OUTSIDE CORNER POST

DESCRIPTION

- 10' 0" Length
- Finish: Woodgrain
- 10 Pcs./Ctn.
- 50 Lbs./Ctn.

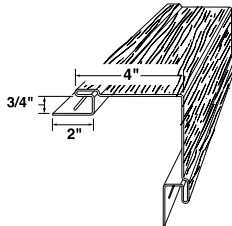

† Solid match for Cottage Gray Shingle Siding.

¥ Solid match for Cabin Cedar Shingle Siding.

STANDARD COLORS

- Autumn Beige
- Classic Cream
- Dover White
- Georgian Gray†
- Heritage Linen
- Island Pearl
- Natural Almond
- Rich Mocha
- Sandtone
- Sandy Tan
- Savannah Blue
- Silver Mist
- Spanish Olive

PREMIUM DARK COLORS

- Bayou
- Briarwood*
- Deep Brunswick
- Mediterranean Palm
- Old Dublin
- Pewter
- Sagebrook
- Sedona Red
- Teak
- Twilight Shadow
- Urban Iron
- Wedgewood

DARK COLORS

- Flint
- Hazelnut
- Irish Thistle
- Southern Cypress
- Stone Mtn. Clay

**FLASHING AND
INSTALLING CORNER
POSTS**



**REPLACING PANELS AND
OUTSIDE CORNERS**



PRODUCT CODE/DESCRIPTION

40029

WIDE FLANGE J-CHANNEL

DESCRIPTION

- 12' 6" Length
- Finish: Low-gloss Pebble
- 20 Pcs./Ctn.
- 55 Lbs./Ctn.

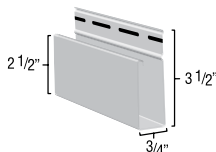

† Solid match for Cottage Gray Shingle Siding

COLOR AVAILABILITY

STANDARD COLORS

- Dover White
- Natural Almond
- Sandy Tan

DARK COLORS

- Stone Mtn. Clay

330

H-MOLD

DESCRIPTION

- 12' 6" Length
- Finish: Low-gloss Pebble
- 24 Pcs./Ctn.
- 55.83 Lbs./Ctn.

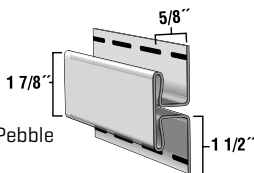

STANDARD COLORS

- Autumn Beige
- Classic Cream
- Dover White
- Georgian Gray
- Heritage Linen
- Island Pearl
- Natural Almond
- Rich Mocha
- Sandtone
- Sandy Tan
- Savannah Blue
- Silver Mist
- Spanish Olive

DARK COLORS

- Flint†
- Irish Thistle
- Stone Mtn. Clay

40027

OUTSIDE CORNER POST

DESCRIPTION

- 12' 0" Length
- Finish: Woodgrain
- 10 Pcs./Ctn.
- 55.39 Lbs./Ctn.

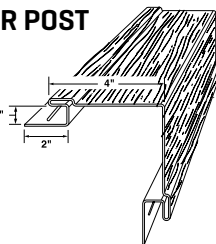

STANDARD COLORS

- Dover White

† Solid match for Cottage Gray Shingle Siding

VINYL ACCESSORIES

PRODUCT CODE/DESCRIPTION

40028

UNDERSILL TRIM

DESCRIPTION

- 12' 6" Length
- Finish: Low-gloss Pebble
- 40 Pcs./Ctn.
- 46 Lbs./Ctn.

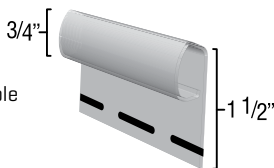

† Solid match for Cottage Gray Shingle Siding.

‡ Solid match for Cabin Cedar Shingle Siding.

COLOR AVAILABILITY

STANDARD COLORS

- Autumn Beige
- Classic Cream
- Dover White
- Georgian Gray
- Heritage Linen
- Island Pearl
- Natural Almond
- Rich Mocha
- Sandtone
- Sandy Tan
- Savannah Blue
- Silver Mist
- Spanish Olive

DARK COLORS

- Flint†
- Hazelnut
- Irish Thistle
- Southern Cypress
- Stone Mtn. Clay

PREMIUM DARK COLORS

- Bayou
- Briarwood*
- Deep Brunswick
- Mediterranean Palm
- Old Dublin
- Pewter
- Sagebrook
- Sedona Red
- Teak
- Twilight Shadow
- Urban Iron
- Wedgewood

396

DUAL UNDERSILL TRIM

DESCRIPTION

- 12' 6" Length
- Finish: Low-gloss Pebble
- 24 Pcs./Ctn.
- 45.16 Lbs./Ctn.

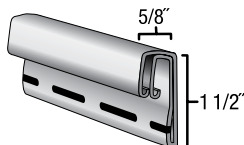

STANDARD COLORS

- Autumn Beige
- Classic Cream
- Dover White
- Georgian Gray
- Heritage Linen
- Island Pearl
- Natural Almond
- Rich Mocha
- Sandtone

- Sandy Tan
- Savannah Blue
- Silver Mist
- Spanish Olive

DARK COLORS

- Flint
- Irish Thistle
- Stone Mtn. Clay

40024

7/8" J-CHANNEL

DESCRIPTION

- 12' 6" Length
- Finish: Low-gloss Pebble
- 40 Pcs./Ctn.
- 48 Lbs./Ctn.

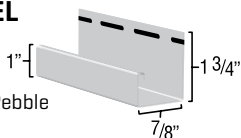

† Solid match for Cottage Gray Shingle Siding.

‡ Solid match for Cabin Cedar Shingle Siding.

STANDARD COLORS

- Autumn Beige
- Classic Cream
- Dover White
- Georgian Gray
- Heritage Linen
- Island Pearl
- Natural Almond
- Rich Mocha
- Sandtone
- Sandy Tan
- Savannah Blue
- Silver Mist
- Spanish Olive

PREMIUM DARK COLORS

- Bayou
- Briarwood‡
- Deep Brunswick
- Mediterranean Palm
- Old Dublin
- Pewter
- Sagebrook
- Sedona Red
- Teak
- Twilight Shadow
- Urban Iron
- Wedgewood

DARK COLORS

- Flint†
- Hazelnut
- Irish Thistle
- Stone Mtn. Clay

J-CHANNEL OPTIONS



PRODUCT CODE/DESCRIPTION

40026

5/8" J-CHANNEL

DESCRIPTION

- 12' 6" Panel
- Finish:
 - Low-gloss Pebble
- 40 Pcs./Ctn.
- 45 Lbs./Ctn.

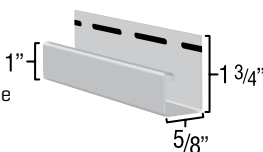

COLOR AVAILABILITY

STANDARD COLORS

- Autumn Beige
- Classic Cream
- Dover White
- Georgian Gray
- Heritage Linen
- Island Pearl
- Natural Almond
- Rich Mocha
- Sandtone
- Sandy Tan
- Savannah Blue
- Silver Mist
- Spanish Olive

DARK COLORS

- Flint
- Hazelnut
- Irish Thistle
- Musket Brown*

- Southern Cypress
 - Stone Mtn. Clay
- PREMIUM DARK COLORS**
- Bayou
 - Briarwood
 - Deep Brunswick
 - Mediterranean Palm
 - Old Dublin
 - Pewter
 - Sagebrook
 - Sedona Red
 - Teak
 - Twilight Shadow
 - Urban Iron
 - Wedgewood

PRODUCT CODE/DESCRIPTION

336

1/2" J-CHANNEL

DESCRIPTION

- 12' 6" Panel
- Finish:
 - Low-gloss Pebble
- 40 Pcs./Ctn.
- 42.34 Lbs./Ctn.

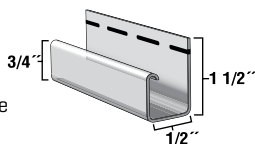

COLOR AVAILABILITY

STANDARD COLORS

- Autumn Beige
- Classic Cream
- Dover White
- Georgian Gray
- Heritage Linen
- Island Pearl
- Natural Almond
- Rich Mocha
- Sandtone
- Sandy Tan
- Savannah Blue
- Silver Mist
- Spanish Olive

DARK COLORS

- Black*
- Flint
- Irish Thistle
- Musket Brown*
- Stone Mtn. Clay

339

1/2" F-TRIM

DESCRIPTION

- 12' 6" Length
- Finish:
 - Low-gloss Pebble
- 40 Pcs./Ctn.
- 45.33 Lbs./Ctn.

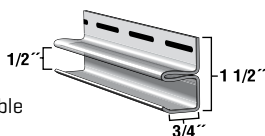

* Musket Brown and Black color is not warranted for sidewall use.

VINYL ACCESSORIES

PRODUCT CODE/DESCRIPTION

364

INSIDE CORNER POST

DESCRIPTION

- 10' 0" Length
- Finish:
Low-gloss Pebble
- 10 Pcs./Ctn.
- 24.43 Lbs./Ctn.

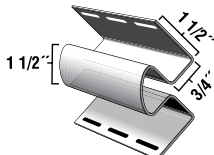

COLOR AVAILABILITY

STANDARD COLORS

Autumn Beige
Classic Cream
Dover White
Georgian Gray
Heritage Linen
Island Pearl
Natural Almond
Rich Mocha
Sandtone
Sandy Tan
Savannah Blue
Silver Mist
Spanish Olive

DARK COLORS

Flint
Hazelnut
Irish Thistle
Southern
Cypress
Stone Mtn. Clay

PREMIUM DARK COLORS

Bayou
Briarwood
Deep Brunswick
Mediterranean
Palm
Old Dublin
Pewter
Sagebrook
Sedona Red
Teak
Twilight Shadow
Urban Iron
Wedgewood

303

VINYL STARTER STRIP

DESCRIPTION

- 10' 0" Length
- 50 Pcs./Ctn.
- 52.50 Lbs./Ctn.

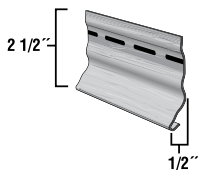

Dover White

ASVSS25

STEEL STARTER STRIP (GALVANIZED)

DESCRIPTION

- Length: 10'
- 25 Pcs./Ctn.
- 40 Lbs./Ctn.

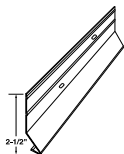

(Not to be installed with aluminum siding)

ASVSS35

STEEL STARTER STRIP (GALVANIZED)

DESCRIPTION

- Length: 10'
- 25 Pcs./Ctn.
- 49 Lbs./Ctn.

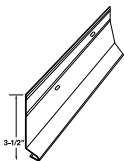

(Not to be installed with aluminum siding)

STARTER STRIP



PRODUCT CODE/DESCRIPTION

COLOR AVAILABILITY

365

2-PIECE WIDE CROWN MOLDING

DESCRIPTION

- 12' 6" Panel
- Finish: Low-gloss Pebble
- Use with Universal Back Plate #366 or Frieze back plate # 367
- 24 Pcs./Ctn.
- 33.71 Lbs./Ctn.

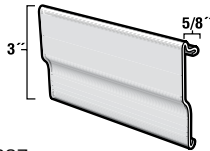

STANDARD COLORS

- Classic Cream
- Dover White
- Georgian Gray
- Island Pearl
- Natural Almond
- Rich Mocha
- Sandy Tan
- Silver Mist

DARK COLORS

- Flint
- Irish Thistle
- Stone Mtn. Clay

366

UNIVERSAL BACK PLATE

DESCRIPTION

- 12' 6" Panel
- Finish: Low-gloss Pebble
- 24 Pcs./Ctn.
- 34.79 Lbs./Ctn.
- For use with 2 piece crown molding

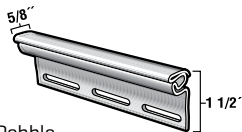

Dover White

367

FRIEZE BACK PLATE

DESCRIPTION

- 12' 6" Panel
- Finish: Low-gloss Pebble
- 24 Pcs./Ctn.
- 44.51 Lbs./Ctn.
- For use with 2 piece crown molding

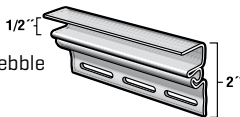

VINYL ACCESSORIES

PRODUCT CODE/DESCRIPTION

COLOR AVAILABILITY

377

Dover White

FLUTED OUTSIDE CORNER

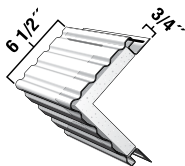

DESCRIPTION

- 20'0" Panel
- Finish: Low-gloss Pebble
- 4 Pcs./Ctn.
- 43.54 Lbs./Ctn.

390

3-3/4" WINDOW & DOOR LINEAL

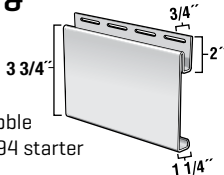

DESCRIPTION

- 20' 0" Length
- Finish: Low-gloss Pebble
- Use with #393 or #394 starter
- 10 Pcs./Ctn.
- 57.95 Lbs./Ctn.

STANDARD COLORS

- Dover White
- Georgian Gray
- Heritage Linen
- Island Pearl
- Sandy Tan

DARK COLOR

- Stone Mtn. Clay

395

Dover White

3-3/4" WINDOW & DOOR LINEAL

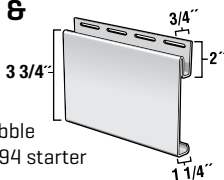

DESCRIPTION

- 12' 6" Length
- Finish: Low-gloss Pebble
- Use with #393 or #394 starter
- 10 Pcs./Ctn.
- 37.72 Lbs./Ctn.

391

5" WINDOW AND DOOR LINEAL

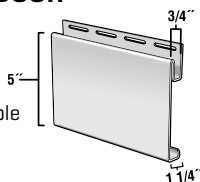

DESCRIPTION

- 20' 0" Length
- Finish: Low-gloss Pebble
- Use with #393 or #394 starter
- 10 Pcs./Ctn.
- 65.62 Lbs./Ctn.

**INSTALL LINEALS
AROUND NEW
& REMODELED
WINDOWS**



**INSTALL LINEALS AS
BAND BOARDS AND
GABLES**



PRODUCT CODE/DESCRIPTION

COLOR AVAILABILITY

393

Dover White

NEW CONSTRUCTION LINEAL STARTER

DESCRIPTION

- 10'0" Length
- For use with #390, #391 and #395 [Window & Door Surround]
- 40 Pcs./Ctn.
- 45.22 Lbs./Ctn.

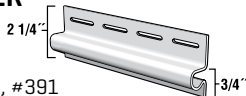

398

LINEAL CORNER STARTER

DESCRIPTION

- 20'0" Length
- Finish: Matte
- 10 Pcs./Ctn.
- 200 Ft./Ctn.
- 61.08 Lbs./Ctn.

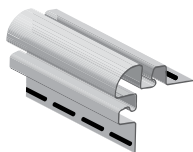

40046

3-1/2" INTERLOCKING FOAM BACKED LINEAL

Dover White
Tan
Clay

DESCRIPTION

- 12'6" Length
- Interlocks into vinyl windows with integrated siding receiver
- 20 Pcs./Ctn./250 Ln. Ft.
- 65 Lbs./Ctn.

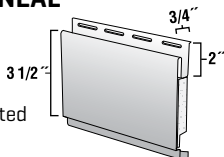

40047

5" INTERLOCKING FOAM BACKED LINEAL

Dover White
Tan
Clay

DESCRIPTION

- 12'6" Length
- Interlocks into vinyl windows with integrated siding receiver
- 15 Pcs./Ctn./187.5 Ln. Ft.
- 58 Lbs./Ctn.

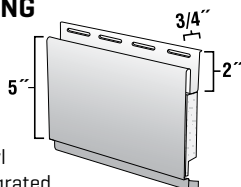

VINYL ACCESSORIES

PRODUCT CODE/DESCRIPTION

COLOR AVAILABILITY

362

Dover White

BAY WINDOW CORNER

DESCRIPTION

- 10' 0" Panel
- Finish: Low-gloss Pebble
- 10 Pcs./Ctn.
- 34.72 Lbs./Ctn.

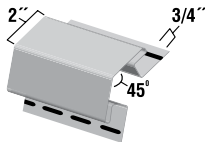

407

TRADITIONAL OUTSIDE CORNER POST

DESCRIPTION

- 20' 0" Panel
- Finish: Low-gloss Pebble
- 4 Pcs./Ctn.
- 67 Lbs./Ctn.

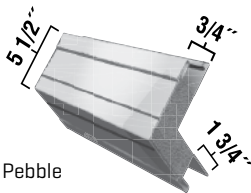

506

Dover White

FLEXIBLE J-CHANNEL

DESCRIPTION

- 12' 6" Panel
- 20 Pcs./Ctn.
- 40 Lbs./Ctn.

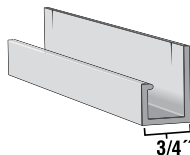

PRODUCT CODE/DESCRIPTION

420

PROGUARD® SOLID VINYL SKIRTING

DESCRIPTION

- 12' 0" Panel
- Product thickness: .032"
- 12 Pcs./Ctn.
- 61 Lbs./Ctn.

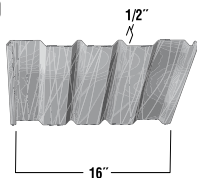

COLOR AVAILABILITY

STANDARD COLORS

- Classic Cream
- Dover White
- Georgian Gray
- Island Pearl
- Sandy Tan

DARK COLORS

- Stone Mtn. Clay

422

PROGUARD® CENTER VENTED VINYL SKIRTING

DESCRIPTION

- 12' 0" Panel
- Product thickness: .032"
- 12 Pcs./Ctn.
- 61 Lbs./Ctn.

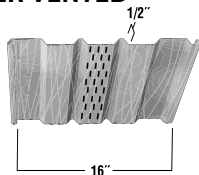

SKIRTING ACCESSORIES

PRODUCT CODE/DESCRIPTION

472

HINGE STYLE TOP FRONT RAIL

DESCRIPTION

- 11' 7-1/4" Length
- 28 Pcs./Ctn.
- 61 Lbs./Ctn.



COLOR AVAILABILITY

STANDARD COLORS

Classic Cream
Dover White
Georgian Gray
Island Pearl
Sandy Tan

DARK COLORS

Stone Mtn. Clay

477

WIND RESISTANT TOP FRONT RAIL

DESCRIPTION

- 11' 7-1/4" Length
- 28 Pcs./Ctn.
- 59 Lbs./Ctn.



471

TOP BACK RAIL

DESCRIPTION

- 11' 6" Length
- 28 Pcs./Ctn.
- 51 Lbs./Ctn.



473

BOTTOM RAIL

DESCRIPTION

- 11' 6" Length
- 28 Pcs./Ctn.
- 58 Lbs./Ctn.



PRODUCT CODE/DESCRIPTION

456

HINGE STYLE TRIM PACK

DESCRIPTION

- Includes 14 [Pcs.] of each:
 - Top Front Rail
 - Top Back Rail
 - Bottom Rail
- 125 - 7" Ground Spikes/Ctn.
- 250 - 1" Attachment Screws/Ctn.
- 98 Lbs./Ctn.

COLOR AVAILABILITY

STANDARD COLORS

- Classic Cream
- Dover White
- Georgian Gray
- Island Pearl
- Sandy Tan

DARK COLORS

- Stone Mtn. Clay

457

WIND RESISTANT TRIM PACK

DESCRIPTION

- Includes 14 [Pcs.] of each:
 - Top Front Rail
 - Top Back Rail
 - Bottom Rail
- 125 - 7" Ground Spikes/Ctn.
- 250 - 1" Attachment Screws/Ctn.
- 98 Lbs./Ctn.

513

**SKIRTING
HARDWARE**



DESCRIPTION

- 125 - 7" Ground Spikes/Ctn.
- 250 - 1" Attachment Screws/Ctn.

TOOLS

PRODUCT CODE/DESCRIPTION

552

SNAP LOCK PUNCH



553

UNLOCK TOOL



554

NAIL HOLE PUNCH



HOW TO USE
VINYL SIDING
SPECIALTY TOOLS

REPLACING PANELS
AND OUTSIDE
CORNERS



STANDARD SHUTTERS

PRODUCT CODE/DESCRIPTION

VINRP12

STANDARD RAISED PANEL SHUTTERS

DESCRIPTION:

- 12" Wide [Nominal]
- High Density Copolymer
- Baked-on Acrylic Finish
- 1 Pair/Ctn.

Product Code	Length	Lbs./Ctn.
VINRP1227	27"	6 Lbs./Ctn.
VINRP1231	31"	7 Lbs./Ctn.
VINRP1235	35"	8 Lbs./Ctn.
VINRP1239	39"	8 Lbs./Ctn.
VINRP1243	43"	9 Lbs./Ctn.
VINRP1247	47"	10 Lbs./Ctn.
VINRP1251	51"	11 Lbs./Ctn.
VINRP1255	55"	12 Lbs./Ctn.
VINRP1259	59"	12 Lbs./Ctn.
VINRP1263	63"	13 Lbs./Ctn.
VINRP1267	67"	13 Lbs./Ctn.
VINRP1271	71"	15 Lbs./Ctn.

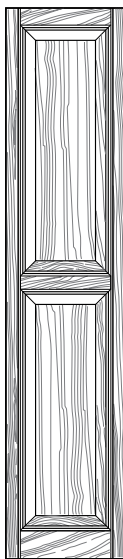

Regular Style

COLOR AVAILABILITY

- 11 White
- 33 Black
- 99 Blackwatch Green
- 41 Blue
- 59 Brown
- BLU Coastal Blue
- IJ Dark Berry
- 95 Dark Navy
- 56 Dark Spruce
- 55 Green
- 16 Grey
- 52 Pebblestone Clay
- PE Peppercorn
- 38 Red
- CRM Sand Dollar
- 93 Spanish Moss
- SL Terra Brown
- SK Vineyard Red
- 58 Winestone

SHERWIN-WILLIAMS®

- EGF Evergreen Fog, SW 9130
- GAF Gale Force, SW 7605
- URB Urbane Bronze, SW 7048

VINRP15

STANDARD RAISED PANEL SHUTTERS

DESCRIPTION:

- 15" Wide [Nominal]
- High Density Copolymer
- Baked-on Acrylic Finish
- 1 Pair/Ctn.

Product Code	Length	Lbs./Ctn.
VINRP1531	31"	6 Lbs./Ctn.
VINRP1535	35"	7 Lbs./Ctn.
VINRP1539	39"	8 Lbs./Ctn.
VINRP1543	43"	9 Lbs./Ctn.
VINRP1547	47"	9 Lbs./Ctn.
VINRP1551	51"	10 Lbs./Ctn.
VINRP1555	55"	10 Lbs./Ctn.
VINRP1559	59"	11 Lbs./Ctn.
VINRP1563	63"	12 Lbs./Ctn.
VINRP1567	67"	13 Lbs./Ctn.
VINRP1567C	67"	13 Lbs./Ctn.
VINRP1571	71"	13 Lbs./Ctn.
VINRP1575	75"	14 Lbs./Ctn.
VINRP1581	81"	15 Lbs./Ctn.

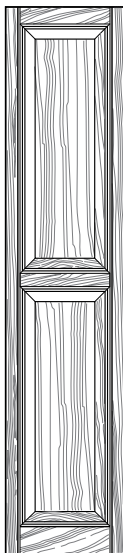

Regular Style

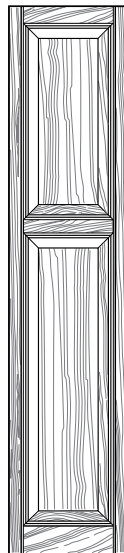

Cottage Style
[67" Length only]

Notes: All shutter dimensions are nominal. All louvered and raised panel shutter cartons include 3" painted steel mounting screws and shutter plugs. Sherwin-Williams® is a registered trademark of SWIMC LLC.

LOUVERED SHUTTERS

PRODUCT CODE/DESCRIPTION

VINLV12

STANDARD OPEN LOUVERED SHUTTERS

DESCRIPTION:

- 12" Wide [Nominal]
- High Density Copolymer
- Baked-on Acrylic Finish
- 1 Pair/Ctn.

Product Code	Length	Lbs./Ctn.
VINLV1255	55"	12 Lbs./Ctn.
VINLV1259	59"	12 Lbs./Ctn.

INSTALLING SHUTTERS

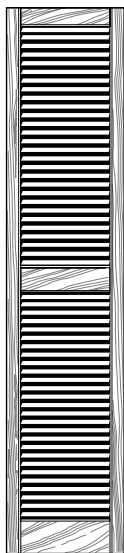

Regular Style

COLOR AVAILABILITY

- 11 White
- 33 Black
- 99 Blackwatch Green
- 41 Blue
- 59 Brown
- BLU Coastal Blue
- IJ Dark Berry
- 95 Dark Navy
- 56 Dark Spruce
- 55 Green
- 16 Grey
- 52 Pebblestone Clay
- PE Peppercorn
- 38 Red
- CRM Sand Dollar
- 93 Spanish Moss
- SL Terra Brown
- SK Vineyard Red
- 58 Winestone

SHERWIN-WILLIAMS®

- EGF Evergreen Fog, SW 9130
- GAF Gale Force, SW 7605
- URB Urbane Bronze, SW 7048

VINLV15

STANDARD OPEN LOUVERED SHUTTERS

DESCRIPTION:

- 15" Wide [Nominal]
- High Density Copolymer
- Baked-on Acrylic Finish
- 1 Pair/Ctn.

Product Code	Length	Lbs./Ctn.
VINLV1525	25"	5 Lbs./Ctn.
VINLV1531	31"	6 Lbs./Ctn.
VINLV1535	35"	7 Lbs./Ctn.
VINLV1539	39"	7 Lbs./Ctn.
VINLV1543	43"	8 Lbs./Ctn.
VINLV1547	47"	8 Lbs./Ctn.
VINLV1551	51"	9 Lbs./Ctn.
VINLV1555	55"	11 Lbs./Ctn.
VINLV1559	59"	11 Lbs./Ctn.
VINLV1563	63"	11 Lbs./Ctn.
VINLV1567	67"	12 Lbs./Ctn.
VINLV1567C	67"	12 Lbs./Ctn.
VINLV1571	71"	12 Lbs./Ctn.
VINLV1575	75"	14 Lbs./Ctn.
VINLV1581	81"	14 Lbs./Ctn.



Regular Style

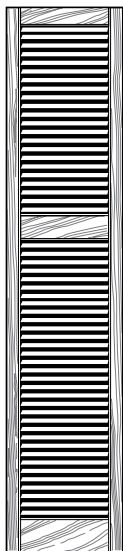

Cottage Style
[67" Length only]

Notes: All shutter dimensions are nominal. All louvered and raised panel shutter cartons include 3" painted steel mounting screws and shutter plugs.

Sherwin-Williams® is a registered trademark of SWIMC LLC.

BOARD+BATTEN SHUTTERS

PRODUCT CODE/DESCRIPTION

VIN3C11 & VIN3012

BOARD+BATTEN STANDARD 3-BOARD SHUTTERS

DESCRIPTION:

- 11"-12" Wide [Nominal]
- High Density Copolymer
- Baked-on Acrylic Finish
- 1 Pair/Ctn.

CLOSED

Product Code	Length	Lbs./Ctn.
VIN3C1131	11"x31"	4.5 Lbs./Ctn.
VIN3C1135	11"x35"	5 Lbs./Ctn.
VIN3C1139	11"x39"	5 Lbs./Ctn.
VIN3C1143	11"x43"	5.5 Lbs./Ctn.
VIN3C1147	11"x47"	6 Lbs./Ctn.
VIN3C1151	11"x51"	6 Lbs./Ctn.
VIN3C1155	11"x55"	7 Lbs./Ctn.
VIN3C1159	11"x59"	7.5 Lbs./Ctn.
VIN3C1163	11"x63"	8 Lbs./Ctn.
VIN3C1167	11"x67"	8.5 Lbs./Ctn.
VIN3C1171	11"x71"	9 Lbs./Ctn.
VIN3C1175	11"x75"	9 Lbs./Ctn.
VIN3C1181	11"x81"	10 Lbs./Ctn.

OPEN

Product Code	Length	Lbs./Ctn.
VIN301231	12"x31"	4.5 Lbs./Ctn.
VIN301235	12"x35"	5 Lbs./Ctn.
VIN301239	12"x39"	5 Lbs./Ctn.
VIN301243	12"x43"	6 Lbs./Ctn.
VIN301247	12"x47"	6 Lbs./Ctn.
VIN301251	12"x51"	6.5 Lbs./Ctn.
VIN301255	12"x55"	7.5 Lbs./Ctn.
VIN301259	12"x59"	8 Lbs./Ctn.
VIN301263	12"x63"	8 Lbs./Ctn.
VIN301267	12"x67"	8.5 Lbs./Ctn.
VIN301271	12"x71"	9 Lbs./Ctn.
VIN301275	12"x75"	9.5 Lbs./Ctn.
VIN301281	12"x81"	10 Lbs./Ctn.

COLOR AVAILABILITY

- 11 White
- 33 Black
- 99 Blackwatch Green
- 41 Blue
- 59 Brown
- BLU Coastal Blue
- IJ Dark Berry
- 95 Dark Navy
- 56 Dark Spruce
- 55 Green
- 16 Grey
- 52 Pebblestone Clay
- PE Peppercorn
- 38 Red
- CRM Sand Dollar
- 93 Spanish Moss
- SL Terra Brown
- SK Vineyard Red
- 58 Winestone

SHERWIN-WILLIAMS®

- EGF Evergreen Fog,
SW 9130
- GAF Gale Force,
SW 7605
- URB Urbane Bronze,
SW 7048



Closed Style



Open Style

INSTALLING SHUTTERS



Notes: All shutter dimensions are nominal. Board+Batten shutter cartons include steel mounting screws.

Lengths 51" and smaller have 2 horizontal boards.

Lengths 55" and longer have 3 horizontal boards.

Sherwin-Williams® is a registered trademark of SWIMC LLC.

BOARD+BATTEN SHUTTERS

PRODUCT CODE/DESCRIPTION

VIN4C15 & VIN4O16

BOARD+BATTEN STANDARD 4-BOARD SHUTTER

DESCRIPTION:

- 15"-16" Wide [Nominal]
- High Density Copolymer
- Baked-on Acrylic Finish
- 1 Pair/Ctn.

CLOSED

Product Code	Length	Lbs./Ctn.
VIN4C1531	15"x31"	6 Lbs./Ctn.
VIN4C1535	15"x35"	6.5 Lbs./Ctn.
VIN4C1539	15"x39"	7 Lbs./Ctn.
VIN4C1543	15"x43"	7.5 Lbs./Ctn.
VIN4C1547	15"x47"	8 Lbs./Ctn.
VIN4C1551	15"x51"	8.5 Lbs./Ctn.
VIN4C1555	15"x55"	10 Lbs./Ctn.
VIN4C1559	15"x59"	10 Lbs./Ctn.
VIN4C1563	15"x63"	10.5 Lbs./Ctn.
VIN4C1567	15"x67"	11 Lbs./Ctn.
VIN4C1571	15"x71"	11.5 Lbs./Ctn.
VIN4C1575	15"x75"	12 Lbs./Ctn.
VIN4C1581	15"x81"	13 Lbs./Ctn.

OPEN

Product Code	Length	Lbs./Ctn.
VIN4O1631	16"x31"	6 Lbs./Ctn.
VIN4O1635	16"x35"	6.5 Lbs./Ctn.
VIN4O1639	16"x39"	7 Lbs./Ctn.
VIN4O1643	16"x43"	7.5 Lbs./Ctn.
VIN4O1647	16"x47"	8 Lbs./Ctn.
VIN4O1651	16"x51"	8.5 Lbs./Ctn.
VIN4O1655	16"x55"	10 Lbs./Ctn.
VIN4O1659	16"x59"	10.5 Lbs./Ctn.
VIN4O1663	16"x63"	11 Lbs./Ctn.
VIN4O1667	16"x67"	11.5 Lbs./Ctn.
VIN4O1671	16"x71"	12 Lbs./Ctn.
VIN4O1675	16"x75"	12.5 Lbs./Ctn.
VIN4O1681	16"x81"	13 Lbs./Ctn.



Closed Style



Open Style

COLOR AVAILABILITY

- 11 White
- 33 Black
- 99 Blackwatch Green
- 41 Blue
- 59 Brown
- BLU Coastal Blue
- IJ Dark Berry
- 95 Dark Navy
- 56 Dark Spruce
- 55 Green
- 16 Grey
- 52 Pebblestone Clay
- PE Peppercorn
- 38 Red
- CRM Sand Dollar
- 93 Spanish Moss
- SL Terra Brown
- SK Vineyard Red
- 58 Winestone

SHERWIN-WILLIAMS®

- EGF Evergreen Fog, SW 9130
- GAF Gale Force, SW 7605
- URB Urbane Bronze, SW 7048

Notes: All shutter dimensions are nominal. Board+Batten shutter cartons include steel mounting screws.

The following lengths of VIN4C are molded panels - 47", 55", 59", 63", and 71".

Lengths 51" and smaller have 2 horizontal boards.

Lengths 55" and longer have 3 horizontal boards.

Sherwin-Williams® is a registered trademark of SWIMC LLC.

BOARD+BATTEN SHUTTERS

PRODUCT CODE/DESCRIPTION

BBARCH

ARCH TOP BOARD+BATTEN SHUTTER

DESCRIPTION:

- 15" Wide (Nominal)
- High Density Copolymer
- Baked-on Acrylic Finish
- 1 Pair/Ctn.

Product Code	Length	Lbs./Ctn.
BBARCH41	41"	7 Lbs./Ctn.
BBARCH43	43"	7.5 Lbs./Ctn.
BBARCH47	47"	8 Lbs./Ctn.
BBARCH57	57"	9.5 Lbs./Ctn.
BBARCH61	61"	10 Lbs./Ctn.
BBARCH65	65"	10.5 Lbs./Ctn.
BBARCH71	71"	11.5 Lbs./Ctn.
BBARCH73	73"	12 Lbs./Ctn.
BBARCH77	77"	12.5 Lbs./Ctn.
BBARCH85	85"	13 Lbs./Ctn.

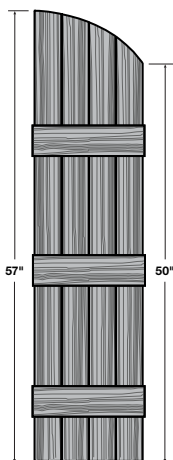

COLOR AVAILABILITY

- 11 White
- 33 Black
- 99 Blackwatch Green
- 41 Blue
- 59 Brown
- BLU Coastal Blue
- IJ Dark Berry
- 95 Dark Navy
- 56 Dark Spruce
- 55 Green
- 16 Grey
- 52 Pebblestone Clay
- PE Peppercorn
- 38 Red
- CRM Sand Dollar
- 93 Spanish Moss
- SL Terra Brown
- SK Vineyard Red
- 58 Winestone

SHERWIN-WILLIAMS®

- EGF Evergreen Fog, SW 9130
- GAF Gale Force, SW 7605
- URB Urbane Bronze, SW 7048

INSTALLING SHUTTERS



Notes: All shutter dimensions are nominal. Board+Batten shutter cartons include steel mounting screws.

Sherwin-Williams® is a registered trademark of SWIMC LLC.

SHUTTER ACCESSORIES

PRODUCT CODE/DESCRIPTION

ARCH15RP

15" RAISED PANEL ARCH TOP

DESCRIPTION

- 15" wide
- 1 Pair./Ctn.
- 3 Lbs./Ctn.

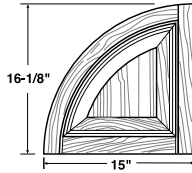

TRANRP15

15" RAISED PANEL TRANSOM TOP

DESCRIPTION

- 15" wide
- 1 Pair./Ctn.
- 3 Lbs./Ctn.

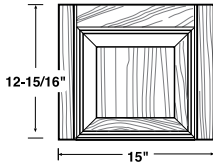

ARCH15LV

15" OPEN LOUVERED ARCH TOP

DESCRIPTION

- 15" wide
- 1 Pair./Ctn.
- 3 Lbs./Ctn.

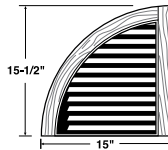

SHUTTRPLUG

FASTENER

DESCRIPTION

- 1/4" x 2-5/8"
- 12 Pcs./ Pkg.

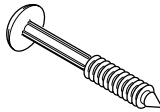

VINITT

PAINTED STEEL REPLACEMENT SCREWS

DESCRIPTION:

- 3/16" x 3"
- 4 Pcs./Pkg.
- .10 Lbs./Ctn.



COLOR AVAILABILITY

- 11 White
- 33 Black
- 99 Blackwatch Green
- 41 Blue
- 59 Brown
- BLU Coastal Blue
- IJ Dark Berry
- 95 Dark Navy
- 56 Dark Spruce
- 55 Green
- 16 Grey
- 52 Pebblestone Clay
- PE Peppercorn
- 38 Red
- CRM Sand Dollar
- 93 Spanish Moss
- SL Terra Brown
- SK Vineyard Red
- 58 Winestone

SHERWIN-WILLIAMS®

- EGF Evergreen Fog, SW 9130
- GAF Gale Force, SW 7605
- URB Urbane Bronze, SW 7048

INSTALLING SHUTTERS



PRODUCT CODE/DESCRIPTION

COLOR AVAILABILITY

SHOOK

33 Black

HOOKS & HINGES



DESCRIPTION:

- [4] Hinges
- [2] S-Hooks (right and left)
- [10] Screws

SHTCLP12

Mill Finish

SHUTTER CLIPS AND ANCHORS



DESCRIPTION:

- 3/16" X 3"
- 12 Pcs. = 1 ea.
- 50 Pcs. = 1 Ctn.

*For standard shutters only

PLY GEM DOOR SURROUNDS

PRODUCT CODE/DESCRIPTION

COLOR AVAILABILITY

11 White [Paintable]

PEDIMENTST

PEDIMENT SET

DESCRIPTION

- Pediment Height: 12-3/4"
- Overall Height: 18-1/2"
- 1 Pc./Ctn.
- 8 Lbs./Ctn.

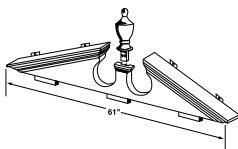

MANTEL

DOOR SURROUND MANTEL

DESCRIPTION

- Length: 58"
- 1 Pc./Ctn.
- 7.41 Lbs./Ctn.

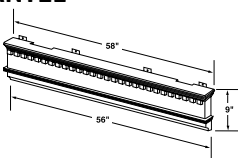

MANTELOVLY

DOOR MANTEL OVERLAY

DESCRIPTION

- Length: 10-1/2"
- 6 Pc./Ctn.
- 6.24 Lbs./Ctn.

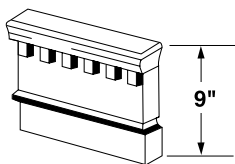

TOPCAP

PILASTER CAP

DESCRIPTION

- 1 Pc./Ctn.
- .23 Lbs./Ctn.

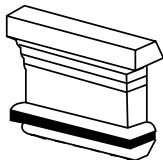

BASECAP

PILASTER BASE

DESCRIPTION

- 1 Pc./Ctn.
- .56 Lbs./Ctn.

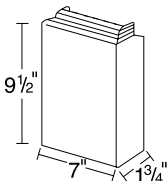

**INSTALLING DOOR
SURROUNDS**



PLY GEM DOOR SURROUNDS

PRODUCT CODE/DESCRIPTION

COLOR AVAILABILITY

PILASTER96

11 White [Paintable]

96" PILASTER SET

DESCRIPTION:

- 2 Pilasters
- 6 Mounting Clips
- 2 Pilaster Caps
- 2 Pilaster Bases
- Width: 7-1/2"
- Height: 96"
- 1 Pair/Ctn.
- 15 Lbs./Ctn.

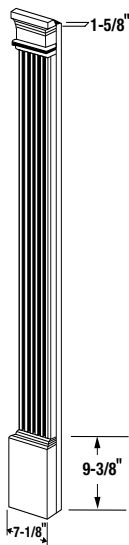

PILASTER144

144" PILASTER SET

DESCRIPTION:

- 2 Pilasters
- 6 Mounting Clips
- 2 Pilaster Caps
- 2 Pilaster Bases
- Width: 7-1/2"
- Height: 144"
- 1 Pair/Ctn.
- 20 Lbs./Ctn.

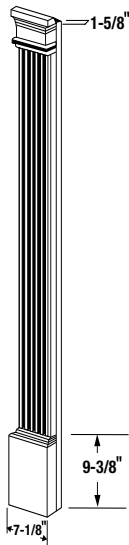

PRODUCT CODE/DESCRIPTION

COLOR AVAILABILITY

MANTEL120

11 White [Paintable]

120" MANTEL SYSTEM

DESCRIPTION

MANTEL SYSTEM INCLUDES:

- 1-Mantel [120"]
- 1-Plain Cover Strip [120"]
- 16-[8] Anchors and [8] Screw/Washers

MANTEL

- Face Height: 7-3/8"
- Length: 120"

PLAIN COVER STRIP

- Height: 1"
- Length: 120"
- Thickness: .139"

- 1 Mantel System/Ctn.
- 15 Lbs./Ctn.

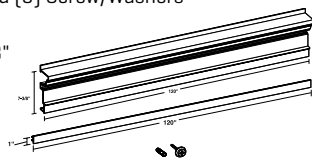

DENTILSTP

60" DENTIL STRIP

DESCRIPTION

- Height: 1"
- Length: 60"
- 2 Pcs./Ctn.
- 2 Lbs./Ctn.

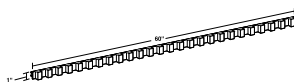

KEYSTN

KEYSTONE FOR 120" MANTEL SYSTEM

DESCRIPTION

- Height: 7-1/2"
- Length: 7"
- Bottom Length: 4-3/4"
- 1 Pc./Ctn.
- 1 Lbs./Ctn.

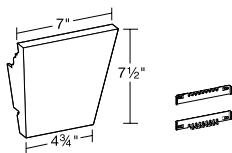

[includes mounting hardware]

**INSTALLING 10 FOOT
MANTEL**



PLY GEM MANTELS

PRODUCT CODE/DESCRIPTION

COLOR AVAILABILITY

SDGENDCAP

11 White [Paintable]

SIDING ENDCAPS FOR 120" MANTEL

DESCRIPTION:

- Height: 7-3/8"
- Width: 3-1/4"
- 2 Pcs./Ctn.
- 2 Lbs./Ctn.

[includes adhesive]

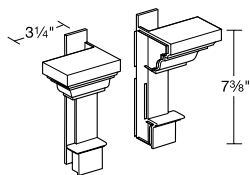

BRKENDCAP

BRICK ENDCAPS FOR 120" MANTEL SYSTEM

DESCRIPTION:

- Height: 7-3/8"
- Width: 3-1/4"
- 2 Pcs./Ctn.
- 2 Lbs./Ctn.

[includes adhesive]

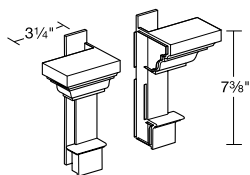

PRODUCT CODE/DESCRIPTION

COLOR AVAILABILITY

PLWINMTL

11 White [Paintable]

36" 40" 44" WINDOW MANTEL

DESCRIPTION

- Height: 7-1/4"
- 1 Pc./Ctn.

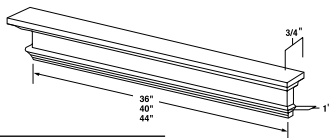

Product Code	Length	Lbs./Ctn.
PLWINMTL36	36"	6 Lbs./Ctn.
PLWINMTL40	40"	7 Lbs./Ctn.
PLWINMTL44	44"	7 Lbs./Ctn.

DTWINMTL

36" 40" 44" WINDOW MANTEL WITH DENTIL TRIM

DESCRIPTION

- Height: 7-1/4"
- 1 Pc./Ctn.

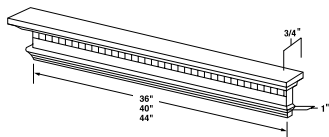

Product Code	Length	Lbs./Ctn.
DTWINMTL36	36"	6 Lbs./Ctn.
DTWINMTL40	40"	7 Lbs./Ctn.
DTWINMTL44	44"	7 Lbs./Ctn.

KEYSTONE

KEYSTONE FOR WINDOW MANTEL

DESCRIPTION

- Height: 8-3/4"
- Length: 7-3/4"
- 1 Pc./Ctn.
- 1 lb/Ctn.

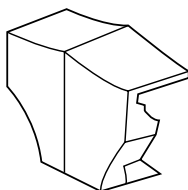

ENDCAP

ENDCAP FOR WINDOW MANTEL

DESCRIPTION

- 1 Pc./Ctn.
- 1 Lb./Ctn.

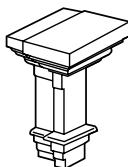

[includes adhesive]

PLY GEM MOUNTING BLOCKS

PRODUCT CODE/DESCRIPTION

UNIBLOCK

J-BLOCK® SQUARE MOUNTING BLOCK

DESCRIPTION

- Mounting Surface: 5" X 6"
- Trim Ring Dimensions: 7-1/4" x 8-1/8"
- J-Channel I.D.: 1/2" adjusts to 1-1/4"
- Knockouts:
 - Round: 4" Diameter
 - Rectangle: 2-3/8" x 3-3/4"
- 10 Pcs./Ctn.
- 6 Lbs./Ctn.

Uses: Light Fixtures,
Electrical Receptacles,
Water Faucets

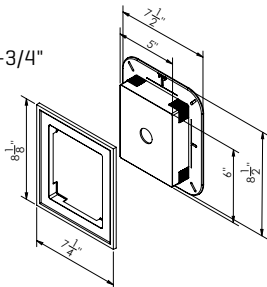

COLOR AVAILABILITY

Available in more than 150 colors to match or coordinate with leading siding manufacturer's colors, including Paintable White [11]. See Ply Gem Accessories [Designer Accents] Color Matrix linked on page 6.

UNIBLOCKSC

J-BLOCK® SQUARE MOUNTING BLOCK SCROLL 4" KNOCKOUT

DESCRIPTION

- Mounting Surface: 5" X 6"
- Trim Ring Dimensions: 7-1/4" x 8-1/8"
- J-Channel I.D.: 1/2" adjusts to 1-1/4"
- Knockouts:
 - Round: 4" Diameter
 - Rectangle: 2-3/8" x 3-3/4"
- 10 Pcs./Ctn.
- 6 Lbs./Ctn.

Uses: Light Fixtures,
Electrical Receptacles,
Water Faucets

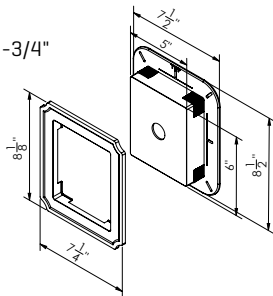

PRODUCT CODE/DESCRIPTION

COLOR AVAILABILITY

MBLOCK

MINI J-BLOCK® MOUNTING BLOCK

DESCRIPTION

- Mounting Surface: 6" x 4-3/8"
- Flange Dimensions: 6 7/8" x 5-1/4"
- J-Channel I.D.: 3/4" adjusts to 1-1/4"
- Knockouts:
 - Round: 1-1/8" Diameter
 - Rectangle: 2-3/8" x 3-3/4"

- 10 Pcs./Ctn.
- 3 Lbs./Ctn.

Uses: Doorbell,
Electrical Outlet

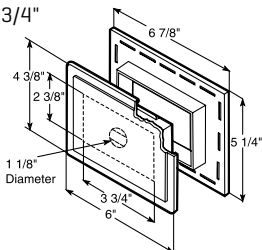

Available in more than 150 colors to match or coordinate with leading siding manufacturer's colors, including Paintable White [11]. See Ply Gem Accessories [Designer Accents] Color Matrix linked on page 6.

MBLOCKR

SPLIT RECESSED J-BLOCK® MOUNTING BLOCK

DESCRIPTION

- Mounting Surface: 3-5/8" x 5-1/4"
- Trim Ring Dimensions: 5-5/8" x 7-3/8"
- J-Channel I.D.: 1/2" adjusts to 1-1/4"
- Knockouts:
 - Rectangle: 2-1/4" x 3-7/8"

- 10 Pcs./Ctn.
- 3.4 Lbs./Ctn.

Uses: Faucets,
Electrical Outlet

*Hinged

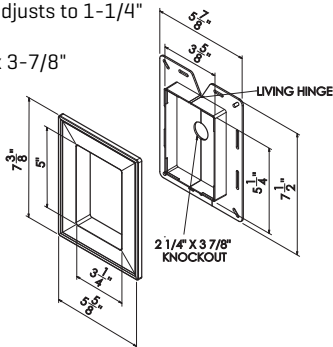

**INSTALL MOUNTING
BLOCKS AND FIXTURE
VENTS**

PLY GEM MOUNTING BLOCKS

PRODUCT CODE/DESCRIPTION

EBLOCK

UL ELECTRICAL BLOCK*

DESCRIPTION

- Mounting Surface: 5" x 6"
- Projection: 2-1/8"
- Trim Ring Dimensions: 7-1/4" x 8-1/8"
- J-Channel I.D.: 1/2" adjusts to 1-1/4"
- 1 Pc./Ctn.
- 1 Lbs./Ctn.

* Includes UL approved black electrical box

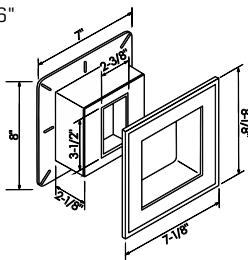

COLOR AVAILABILITY

Available in more than 150 colors to match or coordinate with leading siding manufacturer's colors, including Paintable White [11]. See Ply Gem Accessories [Designer Accents] Color Matrix linked on page 6.

JMBLOCK

LARGE J-BLOCK® MOUNTING BLOCK

DESCRIPTION

- Mounting Surface: 6" x 10-1/8"
- Trim Ring Dimensions: 8-3/8" x 12-1/2"
- J-Channel I.D.: 1/2" adjusts to 1-1/4"
- 5 Pcs./Ctn.
- 4 Lbs./Ctn.

Uses: Light Fixtures, Mailbox, House Numbers
Can be used with insulated siding.
Does not include electrical box.

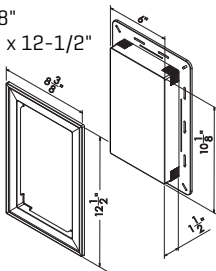

JMBLOCKSC

LARGE J-BLOCK® MOUNTING BLOCK WITH SCROLL CUT SQUARE

DESCRIPTION

- Mounting Surface: 6" x 10-1/8"
- Trim Ring Dimensions: 8-3/8" x 12-1/2"
- J-Channel I.D.: 1/2" adjusts to 1-1/4"
- 5 Pcs./Ctn.
- 4 Lbs./Ctn.

Uses: Light Fixtures, Mailbox, House Numbers
Can be used with insulated siding.
Does not include electrical box.

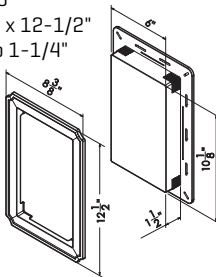

PLY GEM MOUNTING BLOCKS

PRODUCT CODE/DESCRIPTION

JMEBLOCK

LARGE J-BLOCK® MOUNTING BLOCK WITH UL ELECTRICAL BOX*

DESCRIPTION

- Mounting Surface: 6" x 10-1/8"
- Trim Ring Dimensions: 8-3/8" x 12-1/2"
- Adjusts 1/2" - 1-1/4"
- 4 Pcs./Ctn.
- 4.5 Lbs./Ctn.

*Includes UL approved black electrical box

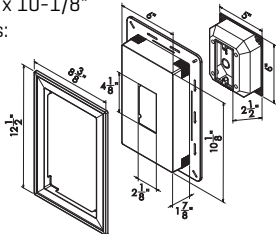

COLOR AVAILABILITY

Available in more than 150 colors to match or coordinate with leading siding manufacturer's colors, including Paintable White [11]. See Ply Gem Accessories [Designer Accents] Color Matrix linked on page 6.

JMEBLOCKSC

LARGE J-BLOCK® MOUNTING BLOCK WITH UL ELECTRICAL BOX SCROLL CUT*

DESCRIPTION

- Mounting Surface: 6" x 10-1/8"
- Trim Ring Dimensions: 8-3/8" x 12-1/2"
- Adjusts 1/2" - 1-1/4"
- 4 Pcs./Ctn.
- 4.5 Lbs./Ctn.

*Includes UL approved black electrical box

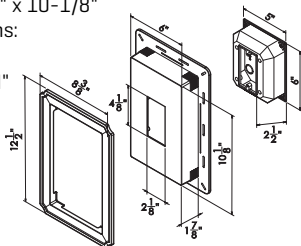

JMEBLOCK

LARGE J-BLOCK® MOUNTING BLOCK WITH UL ELECTRICAL BOX OFFSET*

DESCRIPTION

- Mounting Surface: 6" x 10-1/8"
- Trim Ring Dimensions: 8-3/8" x 12-1/2"
- Adjusts 1/2" - 1-1/4"
- 4 Pcs./Ctn.
- 4.5 Lbs./Ctn.

*Includes UL approved black electrical box

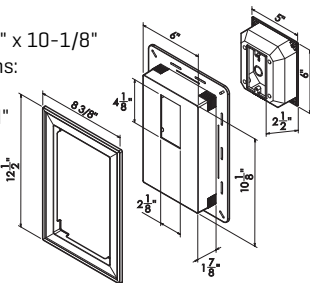

PLY GEM MOUNTING BLOCKS

PRODUCT CODE/DESCRIPTION

JME0BLOCKSC

LARGE J-BLOCK® MOUNTING BLOCK WITH UL ELECTRICAL BOX OFFSET SCROLL*

DESCRIPTION

- Mounting Surface: 6" x 10-1/8"
- Trim Ring Dimensions: 8-3/8" x 12-1/2"
- J-Channel I.D.: 1/2" adjusts to 1-1/4"
- 4 Pcs./Ctn.
- 4.5 Lbs./Ctn.

*Includes UL approved black electrical box

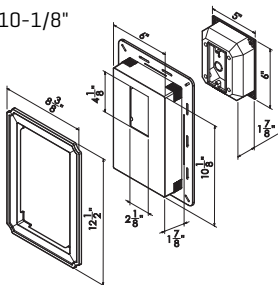

COLOR AVAILABILITY

Available in more than 150 colors to match or coordinate with leading siding manufacturer's colors, including Paintable White [11]. See Ply Gem Accessories [Designer Accents] Color Matrix linked on page 6.

UNIBLOCKXL

LARGE J-BLOCK® MOUNTING BLOCK

DESCRIPTION

- Mounting Surface: 9" x 16"
- Trim Ring Dimensions: 11-3/4" x 18-3/4"
- J-Channel I.D.: 1/2" adjusts to 1-1/4"
- Knockouts:
 - Round: 4" Diameter
 - Rectangle: 2-3/8" x 3-3/4"
- 4 Pcs./Ctn.
- 5 Lbs./Ctn.

Uses: Light Fixtures, Mailbox, House Numbers

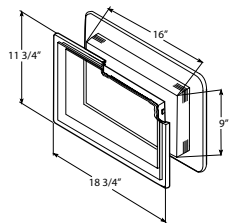

METERLG

JUMBO METER BASE J-BLOCK®

DESCRIPTION

- Mounting Surface: 20" x 24"
- Trim Ring Dimensions: 21-1/2" x 24-1/2"
- J-Channel I.D.: 1/2" adjusts to 1-1/4"
- 1 Pc./Ctn.
- 4 Lbs./Ctn.

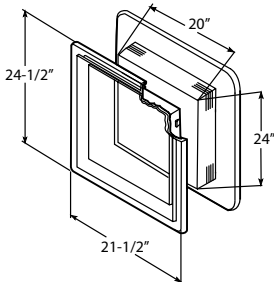

PLY GEM MOUNTING BLOCKS

PRODUCT CODE/DESCRIPTION

METER

METER BASE J-BLOCK®

DESCRIPTION

- Mounting Surface:
16-1/2" x 15-1/2"
- Flange Dimensions:
18-1/2" x 16-3/4"
- J-Channel I.D.: 1-1/4"
- 5 Pcs./Ctn.
- 10 Lbs./Ctn.

Uses: Hose Rack, Electric
Meter Base

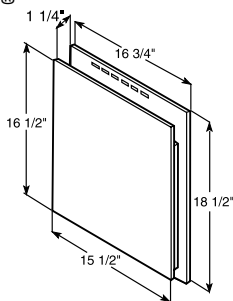

COLOR AVAILABILITY

Available in more than 150 colors to match or coordinate with leading siding manufacturer's colors, including Paintable White [11]. See Ply Gem Accessories [Designer Accents] Color Matrix linked on page 6.



[INSTALL MOUNTING
BLOCKS AND FIXTURE
VENTS](#)

PLY GEM E-Z BLOCK™ MOUNTS

PRODUCT CODE/DESCRIPTION

EZBLK040

SQUARE SURFACE MOUNT (DOUBLE 4" OR DOUBLE 5")

DESCRIPTION

- Surface Dimensions: 6-3/4" x 6-3/4"
- Projections: 3/4"
- Knockouts:
 - Round: 1" Diameter
 - Rectangle: 2-3/8" x 3-3/4"
- 10 Pcs./Ctn.
- 4 Lbs./Ctn.

Uses: Light Fixtures,
Electrical Receptacles,
Water Faucets

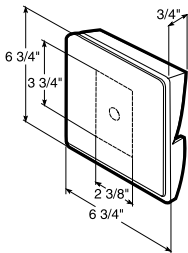

COLOR AVAILABILITY

Available in more than 150 colors to match or coordinate with leading siding manufacturer's colors, including Paintable White [11]. See Ply Gem Accessories [Designer Accents] Color Matrix linked on page 6.

EZBLK070

SQUARE SURFACE MOUNT (DUTCH LAP)

DESCRIPTION

- Surface Dimensions: 6-3/4" x 6-3/4"
- Projections: 3/4"
- Knockouts:
 - Round: 1" Diameter
 - Rectangle: 2-3/8" x 3-3/4"
- 10 Pcs./Ctn.
- 4 Lbs./Ctn.

Uses: Light Fixtures,
Electrical Receptacles,
Water Faucets

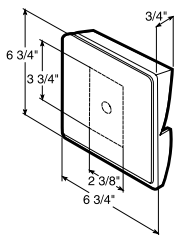

EZBLK080

OCTAGON SURFACE MOUNT (DOUBLE 4" OR DOUBLE 5")

DESCRIPTION

- Surface Dimensions: 6-3/4" x 6-3/4"
- Projections: 3/4"
- Knockouts:
 - Round: 1" Diameter
 - Rectangle: 2-3/8" x 3-3/4"
- 10 Pcs./Ctn.
- 3.34 Lbs./Ctn.

Uses: Light Fixtures, Electrical Outlets, Water Faucets

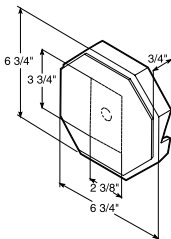

PRODUCT CODE/DESCRIPTION

DRYERHOOD

4" HOODED EXHAUST VENT SYSTEM

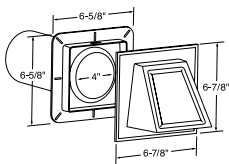

DESCRIPTION

- Flange Dimensions: 6-5/8" x 6-5/8"
- Hood Dimensions: 6-7/8" x 6-7/8"
- Neutral Base
- J-Channel I.D.: 3/4" adjusts to 1-1/4"
- Tube Length: 10"
- Tube Diameter: 4"
- 1 System/Ctn.
- 1 Lb./Ctn.

COLOR AVAILABILITY

Available in more than 150 colors to match or coordinate with leading siding manufacturer's colors, including Paintable White [11]. See Ply Gem Accessories [Designer Accents] Color Matrix linked on page 6.

DRYERHOOD6

6" HOODED EXHAUST VENT SYSTEM

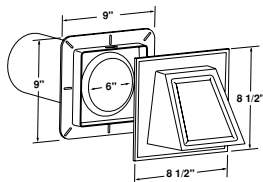

DESCRIPTION

- Flange Dimensions: 9" x 9"
- Hood Dimensions: 8-1/2" x 8-1/2"
- J-Channel I.D.: 3/4" adjusts to 1-1/4"
- Tube Length: 10"
- Tube Diameter: 6"
- 1 System/Ctn.
- 1 Lb./Ctn.

FNDVENT

FOUNDATION VENT

- Flange Dimensions: 20" x 11-1/4"
- Cap Dimensions: 19-7/16" x 10-11/16"
- J-Channel I.D.: 3/4" adjust to 1-1/4"
- Net Free Area: 48 Sq. In.
10 Pcs./Ctn.
11.94 Lbs./Ctn.

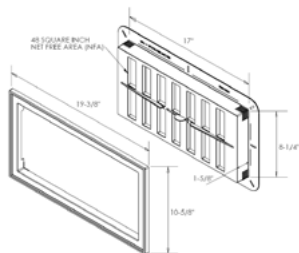

PLY GEM UTILITY VENTS

PRODUCT CODE/DESCRIPTION

EXVENT*

LOUVERED EXHAUST VENT

DESCRIPTION

- Flange Dimensions: 9-1/2" x 9-1/2"
- Surface Dimensions: 8.9" x 8.9"
- J-Channel I.D.:
5/8" adjusts to 1-1/8"
- Net Free Area:
12.5 Sq. In.
- Tube Length: 10"
- Tube Diameter: 4"
- 1 System/Ctn.
- 1.1 Lb./Ctn.

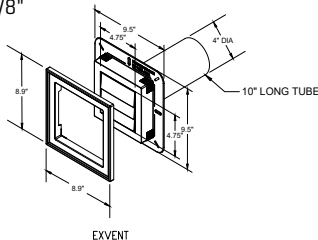

COLOR AVAILABILITY

Available in more than 150 colors to match or coordinate with leading siding manufacturer's colors, including Paintable White [11]. See Ply Gem Accessories [Designer Accents] Color Matrix linked on page 6.

EXVENT6*

6" LOUVERED EXHAUST VENT

DESCRIPTION

- Flange Dimensions: 11-1/2" x 11-1/2"
- Surface Dimensions: 10.9" x 10.9"
- J-Channel I.D.:
5/8" adjusts to 1-1/8"
- Net Free Area:
28.25 Sq. In.
- Tube Length: 10"
- Tube Diameter: 6"
- 1 System/Ctn.
- 1.3 Lb./Ctn.

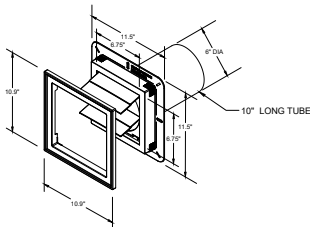

*Not approved for dryer applications with screen installed.

6215013DB

4" OPTIONAL EXVENT SCREEN INSERT

- Dimensions - 4.25" x 4.25"
- Mesh dimensions - 1/8"
- 10 screens/pkg

6215014DB

6" OPTIONAL EXVENT6 SCREEN INSERT

- Dimensions - 6.25" x 6.25"
- Mesh dimensions - 1/8"
- 10 screens/pkg

PRODUCT CODE/DESCRIPTION

INTVENT

INTAKE/EXHAUST VENT

DESCRIPTION

- Flange Dimensions:
7-1/2" x 7-1/2"
- Cap Dimensions: 8" x 8"
- J-Channel I.D.:
1/2" adjusts to 1-1/4"
- Net Free Area: 12.3 Sq. In.
- Tube Length: 10"
- Tube Diameter: 4"
- 1 Pc./Ctn.
- 1 Lb./Ctn.

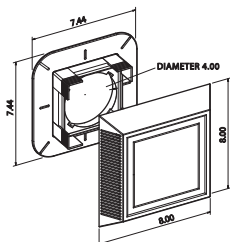

COLOR AVAILABILITY

Available in more than 150 colors to match or coordinate with leading siding manufacturer's colors, including Paintable White [11]. See Ply Gem Accessories [Designer Accents] Color Matrix linked on page 6.

FIRE HAZARD

NEVER use exhaust vent with screen for dryer ventilation. Flammable lint build-up on screen can cause a fire. Always use a vent that is specifically designed for dryer applications.

INTVENT6

6" INTAKE/EXHAUST VENT

DESCRIPTION

- Flange Dimensions:
9-1/2" x 9-1/2"
- Cap Dimensions: 10" x 10"
- J-Channel I.D.:
1/2" adjusts to 1-1/4"
- Net Free Area: 14.75 Sq. In.
- Tube Length: 10"
- Tube Diameter: 6"
- 1 Pc./Ctn.
- 1.2 Lb./Ctn.

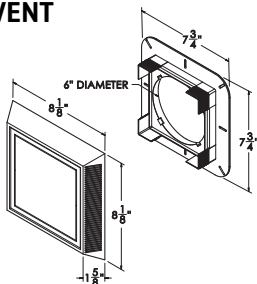

FIRE HAZARD

NEVER use exhaust vent with screen for dryer ventilation. Flammable lint build-up on screen can cause a fire. Always use a vent that is specifically designed for dryer applications.



**INSTALL MOUNTING
BLOCKS AND FIXTURE
VENTS**

PLY GEM GABLE VENTS

PRODUCT CODE/DESCRIPTION

RDGV18

18" ROUND GABLE VENT

DESCRIPTION

- Siding Receiver: 3/4"-1-1/4" in 1/8" increments
- Net Free Area: 48.36 Sq. In.
- 2.3 Lbs./Ctn.
- 1 Pc/Ctn.

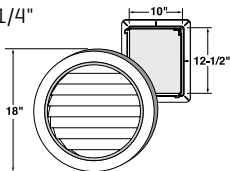

COLOR AVAILABILITY

Available in more than 150 colors to match or coordinate with leading siding manufacturer's colors, including Paintable White (11). See Ply Gem Accessories (Designer Accents) Color Matrix linked on page 6.

RDGV

22" ROUND GABLE VENT

DESCRIPTION

- Siding Receiver: 3/4"-1-1/4" in 1/8" increments
- Net Free Area: 48.37 Sq. In.
- 4.1 Lbs./Ctn.
- 1 Pc/Ctn.

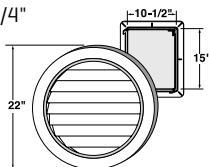

RDGV36

36" ROUND GABLE VENT

DESCRIPTION

- Siding Receiver: 3/4"-1-1/4" in 1/8" increments
- Net Free Area: 277.1 Sq. In.
- 8 Lbs./Ctn.
- 1 Pc/Ctn.

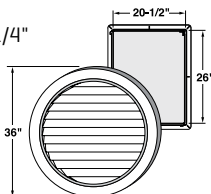

PRODUCT CODE/DESCRIPTION

OCTGV18

18" OCTAGONAL GABLE VENT

DESCRIPTION

- Siding Receiver: 3/4" - 1-1/4" in 1/8" increments
- Net Free Area: 49.72 Sq. In.
- 2.4 Lbs./Ctn.
- 1 Pc/Ctn.

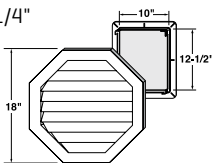

COLOR AVAILABILITY

Available in more than 150 colors to match or coordinate with leading siding manufacturer's colors, including Paintable White [11]. See Ply Gem Accessories [Designer Accents] Color Matrix linked on page 6.

OCTGV

22" OCTAGONAL GABLE VENT

DESCRIPTION

- Siding Receiver: 3/4" - 1-1/4" in 1/8" increments
- Net Free Area: 49.5 Sq. In.
- 5 Lbs./Ctn.
- 1 Pc/Ctn.

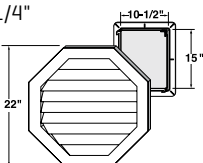

HRDGV

22" HALF ROUND GABLE VENT

DESCRIPTION

- Siding Receiver: 3/4" - 1-1/4" in 1/8" increments
- Net Free Area: 80.46 Sq. In.
- 8 Lbs./Ctn.
- 1 Pc/Ctn.

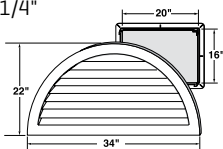

INSTALL GABLE VENTS

PLY GEM GABLE VENTS

PRODUCT CODE/DESCRIPTION

RDTOPGV14

14" X 22" ROUND TOP GABLE VENT

DESCRIPTION

- Siding Receiver: 3/4" - 1-1/4" in 1/8" increments
- Net Free Area: 53.17 Sq. In.
- 2.7 Lbs./Ctn.
- 1 Pc/Ctn.

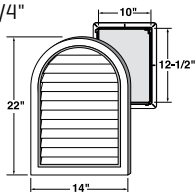

COLOR AVAILABILITY

Available in more than 150 colors to match or coordinate with leading siding manufacturer's colors, including Paintable White (11). See Ply Gem Accessories (Designer Accents) Color Matrix linked on page 6.

RDTOPGV24

24" X 34" ROUND TOP GABLE VENT

DESCRIPTION

- Siding Receiver: 3/4" - 1-1/4" in 1/8" increments
- Net Free Area: 191 Sq. In.
- 6 Lbs./Ctn.
- 1 Pc/Ctn.

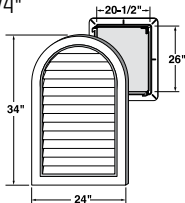

PRODUCT CODE/DESCRIPTION

SQGV1414

14" SQUARE GABLE VENT

DESCRIPTION

- Siding Receiver: 3/4" - 1-1/4" in 1/8" increments
- Net Free Area: 33.59 Sq. In.
- 2.3 Lbs./Ctn.
- 1 Pc/Ctn.

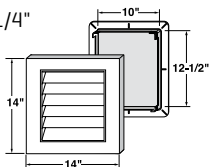

COLOR AVAILABILITY

Available in more than 150 colors to match or coordinate with leading siding manufacturer's colors, including Paintable White [11]. See Ply Gem Accessories [Designer Accents] Color Matrix linked on page 6.

RECTGV

14" X 20" RECTANGULAR GABLE VENT

DESCRIPTION

- Siding Receiver: 3/4" - 1-1/4" in 1/8" increments
- Net Free Area: 23.29 Sq. In.
- 3.83 Lbs./Ctn.
- 1 Pc/Ctn.

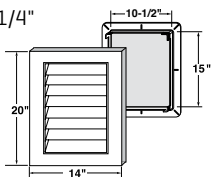

INSTALL GABLE VENTS

PLY GEM GABLE VENTS

PRODUCT CODE/DESCRIPTION

RECTGV1824

18" X 24" RECTANGULAR GABLE VENT

DESCRIPTION

- Siding Receiver: 3/4"-1-1/4" in 1/8" increments
- Net Free Area: 92.88 Sq. In.
- 5.68 Lbs./Ctn.
- 1 Pc/Ctn.

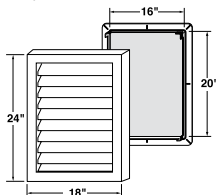

COLOR AVAILABILITY

Available in more than 150 colors to match or coordinate with leading siding manufacturer's colors, including Paintable White [11]. See Ply Gem Accessories [Designer Accents] Color Matrix linked on page 6.

RECTGV2430

24" X 30" RECTANGULAR

DESCRIPTION

- Siding Receiver: 3/4"-1-1/4" in 1/8" increments
- Net Free Area: 181.2 Sq. In.
- 9 Lbs./Ctn.
- 1 Pc/Ctn.

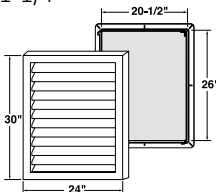

TRIM SHEET

Product Code/Description	Color Code	Color on Front	Color on Back
TS24024	04	White	White
Smooth	33	Black	White
24" Ultra TS®	53	Almond	White
• (Coated two sides)	44	Linen	White
• Nominal Thickness: .024	59	Musket Brown	White
• Length: 50'	52	Pebblestone Clay	White
• 1 Roll/Ctn.	62	Royal Brown	White
• 33.2 Lbs./Ctn.	A7	Wicker	White

TS24024T	04	White	
PVC Coated	59	Musket Brown	
24" Ultra TS®			
• (Coated one side)			
• Finish: PVC Striated			
• Nominal Thickness: .024			
• Length: 50'			
• 1 Roll/Ctn.			
• 35.5 Lbs./Ctn.			

TRIM SHEET

Product Code/Description

Color Code Color on Front Color on Back

TS14

04 White

Smooth

59 Musket Brown

14" Trim Sheet

- (Coated two sides)
- Nominal Thickness: .019
- Length: 50'
- 1 Roll/Ctn.
- 15 Lbs./Ctn.

TRIM COIL

Product Code/Description	Color Code	Color on Front	Color on Back
S24	04	White	White
Smooth	33	Black	White
24" Trim Coil	BM	*Black	Musket Brown
• (Coated two sides)	BR	*Black	Royal Brown
• Finish: Alumalure 2000®	53	Almond	White
• Nominal Thickness: .019	224	*Antique Ivory	White
• Length: 50'	251	Autumn Harvest	White
• 1 Roll/Ctn.	145	*Bayou	White
• 24.6 Lbs./Ctn.	YR	Brandy	White
	147	Brandy Wood	White
	09	*Bronze	White
	812	Brunswick	White
	31	Cameo	White
	80	*Charcoal Grey	White
	802	Cinnabar	White
	803	Civic Brownstone	White
	30	Classic Cream	White
	210	Corn Silk	White
	JS	Dark Bronze	White
	090	Deep Granite	White
	22	Desert Sand	White
	813	Dublin	White
	390	English Wedgewood	White
	17	Everest	White
	70	Evergreen	White
	262	Grecian Green	White
	35	Harbor Grey	White
	814	Iron	White
	AO	Jefferson Tan	White
	IC	Lakeshore Fern	White
	44	Linen	White
	JN	London Brown	White
	148	Mahogany	White
	144	Misty Shadow	White
	IF	Montana Suede	White
	59	Musket Brown	White
	156	Natural Slate	White
	146	Newport Bay	White
	52	Pebblestone Clay	White
	IB	Portsmouth Blue	White
	170	Quiet Willow	White
	149	Red Brick	White
	62	Royal Brown	White
	100	Rugged Canyon	White
	290	Russet Red	White
	18	Sage	White
	39	Sandtone	White
	510	Scottish Thistle	White
	02	Silver Grey	White
	34	Terra Bronze	White
	275	Timberstone	White
	511	Tuscan Olive	White
	228	Tuxedo Gray	White
	36	Victorian Grey	White
	252	Vineyard Grove	White
	A7	Wicker	White

* Colors indicated with an asterisk are not available in PVC coated.

Other colors may be available by Special Order. Please review the Ply Gem Performance Metals Color Offering Matrix and contact your Territory Sales Manager.

TRIM COIL

Product Code/Description	Color Code	Color on Front	Color on Back
S24150	04	White	
Smooth	274	Window White	
24" Trim Coil			
<ul style="list-style-type: none"> • Finish: Smooth • Nominal Thickness: .019 • Length: 150' • 1 Roll/Ctn. • 74.3 Lbs./Ctn. 			
<hr/>			
S24T150			
PVC Coated			
24" Trim Coil			
<ul style="list-style-type: none"> • Nominal Thickness: .019 • Length: 150' • 1 Roll/Ctn. • 74.3 Lbs./Ctn. 			
<hr/>			
S24LM	04	White	
Low Mar	33	Black	
24" Trim Coil	53	Almond	
<ul style="list-style-type: none"> • Finish: Textured Polymer • Nominal Thickness: .019 • Length: 50' • 1 Roll/Ctn. • 24.5 Lbs./Ctn. 	59	Musket Brown	
	52	Pebblestone Clay	
	A7	Wicker	
	62	Royal Brown	
	JS	Dark Bronze	
	Window World		
	274	Window White	
	276	Window Almond	

Other colors may be available by Special Order. Please review the Ply Gem Performance Metals Color Offering Matrix and contact your Territory Sales Manager.

TRIM COIL

Product Code/Description	Color Code	Color on Front	Color on Back
S24W	04	White	
Woodgrain Emboss	33	Black	
24" Trim Coil			
<ul style="list-style-type: none">• Finish: Smooth• Nominal Thickness: .019• Length: 50'• 1 Roll/Ctn.• 24.5 Lbs./Ctn.			
S14	04	White	White
Smooth	BM	Black	Musket Brown
14" Trim Coil	BR	Black	Royal Brown
<ul style="list-style-type: none">• (Coated two sides)• Finish: Smooth• Nominal Thickness: .019• Length: 50'• 1 Roll/Ctn.• 14.4 Lbs./Ctn.			

Product Code/Description	Color Code	Color on Front	Color on Back
C24	04	White	White
Smooth	BM	Black	Musket Brown
24" Trim Coil	BR	Black	Royal Brown
• (Coated two sides)	33	Black	White
• Finish: Smooth Polymer	59	Musket Brown	White
• Nominal Thickness: .018	52	Pebblestone Clay	White
• Length: 50'	276	Window Almond	Window White
• 1 Roll/Ctn.			
• 23.6 Lbs./Ctn.			

C24T 04 White

PVC Coated
24" Trim Coil

- (Coated one side)
- Finish: PVC Striated
- Nominal Thickness: .018
- Length: 50'
- 1 Roll/Ctn.
- 24 Lbs./Ctn.

ENVOY® ALUMINUM SIDING

Product Code/Description

Color Availability

4NCR024

Envoy Rustic Double 4" (.024)

- Finish: Alupalure 2000®
- Nominal Thickness: .024
- Length: 12' 6"
- 24 Pcs./Ctn.
- 2 Sqs./Ctn.
- 90 Lbs./Ctn.

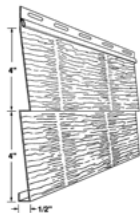

White
Almond
Charcoal Grey
Desert Sand
Everest
Pebblestone Clay
Rugged Canyon
Sandtone
Victorian Grey
Wicker

5N090024

Envoy Horizon Collection Double 5"

- Finish: Alupalure 2000®
- Nominal Thickness: .024
- Length: 12'
- 20 Pcs./Ctn.
- 2 Sqs./Ctn.
- 86 Lbs./Ctn.

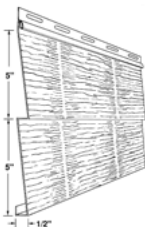

8NA

Envoy 8" Smooth

- Finish: Alupalure 2000®
- Nominal Thickness: .024
- Length: 12' 6"
- 24 Pcs./Ctn.
- 2 Sqs./Ctn.
- 84 Lbs./Ctn.



White

ENDURANCE[®] ALUMINUM SIDING

Product Code/Description

Color Availability

4NCR

Endurance Rustic Double 4"

- Finish: AlumaLure 2000[®]
- Nominal Thickness: .019
- Length: 12' 6"
- 24 Pcs./Ctn.
- 2 Sqs./Ctn.
- 71 Lbs./Ctn.

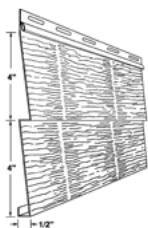

White
Almond
Charcoal Grey
Desert Sand
Everest
Pebblestone Clay
Rugged Canyon
Sandtone
Victorian Grey
Wicker

8NA019

Endurance 8" Smooth

- Finish: AlumaLure 2000[®]
- Nominal Thickness: .019
- Length: 12' 6"
- 24 Pcs./Ctn.
- 2 Sqs./Ctn.
- 72 Lbs./Ctn.

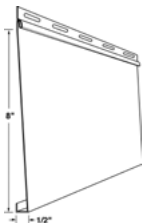

White

ALUMINUM SIDING ACCESSORIES

Product Code/Description

Color Availability

1WAP10

Starter Strip

- Length: 10' 0"
- 40 Pcs./Ctn.
- 27 Lbs./Ctn.

* Required starter strip for Charleston Beaded and Ovation Beaded.

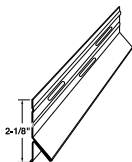

VSS10NS

Starter Strip Spring Style

- Length: 10' 0"
- 50 Pcs./Ctn.
- 33 Lbs./Ctn.

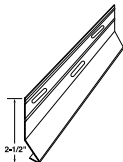

VSSSTD

STANDARD ALUMINUM STARTER STRIP

- 10' 0" Length
- 2.1875" wide
- 50 Pcs./Ctn.
- 27.4 Lbs./Ctn.

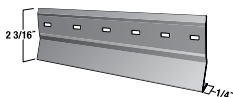

6N225NCR

Rustic Outside Aluminum Corner Post

- Finish: Alupalure 2000®
- Nominal Thickness: .024
- Length: 10'
- 10 Pcs./Ctn.
- 31.7 Lbs./Ctn.

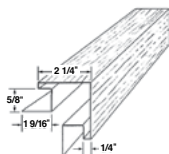

White
Almond
Charcoal Grey
Desert Sand
Everest
Pebblestone Clay
Rugged Canyon
Sandtone
Victorian Grey
Wicker

6N225

Smooth Outside Aluminum Corner Post

- Finish: Alupalure 2000®
- Nominal Thickness: .024
- Length: 10'
- 10 Pcs./Ctn.
- 31.7 Lbs./Ctn.

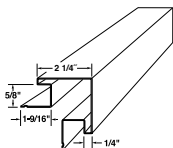

White

ALUMINUM SIDING ACCESSORIES

Product Code/Description

Color Availability

2JN2A25

Window Trim "J" Style

- Finish: Alupalure 2000®
- Nominal Thickness: .019
- Length: 12' 0"
- 25 Pcs./Ctn.
- 18.8 Lbs./Ctn.

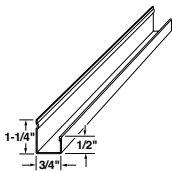

White
Almond
Charcoal Grey
Desert Sand
Everest
Pebblestone Clay
Sandtone
Victorian Grey

3F

Window Head Flashing

- Finish: Alupalure 2000®
- Nominal Thickness: .019
- Length: 12' 6"
- 20 Pcs./Ctn.
- 16.8 Lbs./Ctn.

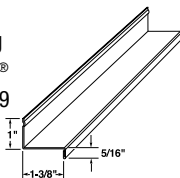

White
Black
Classic Cream
Dark Bronze
Evergreen
Musket Brown
Pebblestone Clay
Royal Brown
Rugged Canyon

Terra Bronze
Wicker

ENVOY® ALUMINUM SOFFIT

Product Code/Description

Color Availability

SVG12N20

Envoy
Double 6" Solid
V-Groove Soffit

- Finish: Alupalure 2000®
- Nominal Thickness: .019
- Length: 12'
- Exposure: 12"
- 20 Pcs./Ctn.
- 240 Sq. Ft./Ctn.
- 75 Lbs./Ctn.

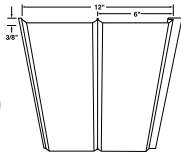

White
Black
Almond
Cameo
Charcoal Grey
Classic Cream
Dark Bronze
Desert Sand
Evergreen
Harbor Grey
Linen
Montana Suede
Musket Brown
Pebblestone Clay
Royal Brown
Rugged Canyon
Sandtone
Silver Grey
Terra Bronze
Victorian Grey
Wicker

SVG12V20

Envoy
Double 6" Perforated
V-Groove Soffit

- Finish: Alupalure 2000®
- Nominal Thickness: .019
- 15 Sq. In. N.F.A./Ft.
- Length: 12'
- Exposure: 12"
- 20 Pcs./Ctn.
- 240 Sq. Ft./Ctn.
- 67 Lbs./Ctn.

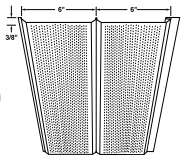

SVG6N

Envoy
6" Solid
V-Groove Soffit

- Finish: Alupalure 2000®
- Nominal Thickness: .019
- Length: 12'
- Exposure: 6"
- 20 Pcs./Ctn.
- 120 Sq. Ft./Ctn.
- 43 Lbs./Ctn.

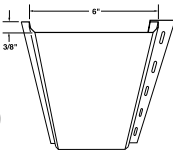

White
Almond
Charcoal Grey
Evergreen
Musket Brown
Pebblestone Clay
Sandtone
Terra Bronze

PLY GEM PERFORMANCE METALS

ENVOY® ALUMINUM SOFFIT

Product Code/Description

Color Availability

SVG6V

Envoy
6" Perforated
V-Groove Soffit

- Finish: AlumaLure 2000®
- Nominal Thickness: .019
- 7.5 Sq. In. N.F.A./Ft.
- Length: 12'
- Exposure: 6"
- 20 Pcs./Ctn.
- 120 Sq. Ft./Ctn.
- 39 Lbs./Ctn.

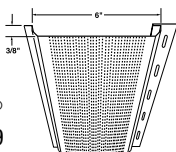

White

SAS12219

Envoy
Double 6" Solid
U-Groove Soffit

- Finish: AlumaLure 2000®
- Nominal Thickness: .019
- Length: 12'
- Exposure: 12"
- 20 Pcs./Ctn.
- 240 Sq. Ft./Ctn.
- 76.1 Lbs./Ctn.

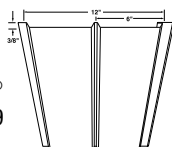

White
Musket Brown

LFAS12219

Envoy
Double 6" Lanced
U-Groove Soffit

- Finish: AlumaLure 2000®
- Nominal Thickness: .019
- 10.6 Sq. In. N.F.A./Ft.
- Length: 12'
- Exposure: 12"
- 20 Pcs./Ctn.
- 240 Sq. Ft./Ctn.
- 76.1 Lbs./Ctn.

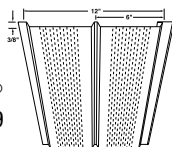

ENVOY® ALUMINUM SOFFIT

Product Code/Description

Color Availability

SAS12319

Envoy
Triple 4" Solid
U-Groove Soffit

- Finish: Alupalure 2000®
- Nominal Thickness: .019
- Length: 12'
- Exposure: 12"
- 20 Pcs./Ctn.
- 240 Sq. Ft./Ctn.
- 77.7 Lbs./Ctn.

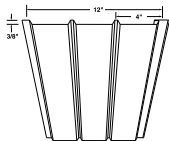

White
Black
Almond
Cameo
Charcoal Grey
Classic Cream
Dark Bronze
Desert Sand
Everest
Evergreen
Harbor Grey
Linen
Montana Suede
Musket Brown
Pebblestone Clay
Royal Brown
Rugged Canyon
Sandtone
Silver Grey
Terra Bronze
Victorian Grey
Wicker

LCAS12319

Envoy
Triple 4" Center Lanced
U-Groove Soffit

- Finish: Alupalure 2000®
- Nominal Thickness: .019
- 4.4 Sq. In. N.F.A./Ft.
- Length: 12'
- Exposure: 12"
- 20 Pcs./Ctn.
- 240 Sq. Ft./Ctn.
- 77.7 Lbs./Ctn.

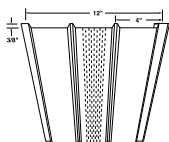

LFAS12319

Envoy
Triple 4" Full Lanced
U-Groove Soffit

- Finish: Alupalure 2000®
- Nominal Thickness: .019
- 13.2 Sq. In. N.F.A./Ft.
- Length: 12'
- Exposure: 12"
- 20 Pcs./Ctn.
- 240 Sq. Ft./Ctn.
- 77.7 Lbs./Ctn.

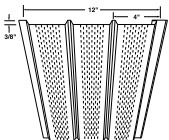

ENVOY® ALUMINUM SOFFIT

Product Code/Description

Color Availability

SAS16419A

Envoy

**Quad 4" Solid
U-Groove Soffit**

- Finish: AlumaLure 2000®
- Nominal Thickness: .019
- Length: 12'
- Exposure: 16"
- 14 Pcs./Ctn.
- 220 Sq. Ft./Ctn.
- 74.2 Lbs./Ctn.

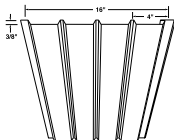

White
Black
Almond
Cameo
Charcoal Grey
Classic Cream
Dark Bronze
Desert Sand
Evergreen
Harbor Grey
Linen
Montana Suede
Musket Brown
Pebblestone Clay
Royal Brown
Rugged Canyon
Sandtone
Silver Grey
Terra Bronze
Victorian Grey
Wicker

LCAS16419A

Envoy

**Quad 4" Center
Lanced U-Groove Soffit**

- Finish: AlumaLure 2000®
- Nominal Thickness: .019
- 9.7 Sq. In. N.F.A./Ft.
- Length: 12'
- Exposure: 16"
- 14 Pcs./Ctn.
- 220 Sq. Ft./Ctn.
- 74.2 Lbs./Ctn.

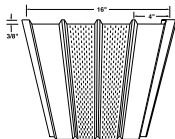

ENDURANCE[®] ALUMINUM SOFFIT

Product Code/Description

Color Availability

SVGN420144

**Endurance
Double 6" Solid
V-Groove Soffit**

- Finish: Alupalure 2000[®]
- Nominal Thickness: .016
- Length: 12'
- Exposure: 12"
- 20 Pcs./Ctn.

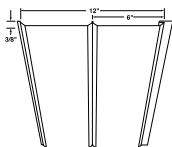

- 240 Sq Ft./Ctn.
- 65 Lbs./Ctn.

- White
- Black
- Almond
- Cameo
- Charcoal Grey
- Classic Cream
- Dark Bronze
- Desert Sand
- Evergreen
- Harbor Grey
- Linen
- Montana Suede
- Musket Brown
- Pebblestone Clay
- Royal Brown
- Sandtone
- Silver Grey
- Terra Bronze
- Victorian Grey
- Wicker

SVG420144

**Endurance
Double 6" Perforated
V-Groove Soffit**

- Finish: Alupalure 2000[®]
- Nominal Thickness: .016
- 15 Sq. In. N.F.A./Ft.
- Length: 12'
- Exposure: 12"
- 20 Pcs./Ctn.

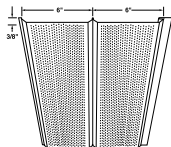

- 240 Sq Ft./Ctn.
- 59 Lbs./Ctn.

SAS12216

**Endurance
Double 6" Solid
U-Groove Soffit**

- Finish: Alupalure 2000[®]
- Nominal Thickness: .016
- Length: 12'
- Exposure: 12"
- 20 Pcs./Ctn.

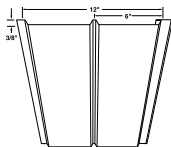

- 240 Sq Ft./Ctn.
- 67 Lbs./Ctn.

- White
- Musket Brown

LFAS12216

**Endurance
Double 6" Lanced
U-Groove Soffit**

- Finish: Alupalure 2000[®]
- Nominal Thickness: .016
- 10.6 Sq. In. N.F.A./Ft.
- Length: 12'
- Exposure: 12"
- 20 Pcs./Ctn.
- 240 Sq Ft./Ctn.
- 67 Lbs./Ctn.

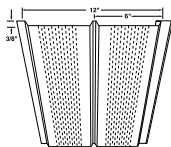

PLY GEM PERFORMANCE METALS

ENDURANCE[®] ALUMINUM SOFFIT

Product Code/Description

Color Availability

SAS12316

Endurance
Triple 4" Solid
U-Groove Soffit

- Finish: Alupalure 2000[®]
- Nominal Thickness: .016
- Length: 12'
- Exposure: 12"
- 20 Pcs./Ctn.
- 240 Sq Ft./Ctn.
- 68 Lbs./Ctn.

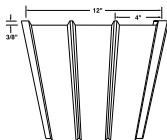

- White
- Black
- Almond
- Cameo
- Charcoal Grey
- Classic Cream
- Dark Bronze
- Desert Sand
- Evergreen
- Harbor Grey
- Linen
- Montana Suede
- Musket Brown
- Pebblestone Clay
- Royal Brown
- Rugged Canyon
- Sandtone
- Silver Grey
- Terra Bronze
- Victorian Grey
- Wicker

LCAS12316

Endurance
Triple 4" Center Lanced
U-Groove Soffit

- Finish: Alupalure 2000[®]
- Nominal Thickness: .016
- 4.4 Sq. In. N.F.A./Ft.
- Length: 12'
- Exposure: 12"
- 20 Pcs./Ctn.
- 240 Sq Ft./Ctn.
- 69 Lbs./Ctn.

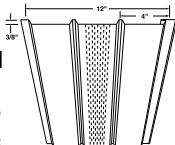

LFAS12316

Endurance
Triple 4" Full Lanced
U-Groove Soffit

- Finish: Alupalure 2000[®]
- Nominal Thickness: .016
- 13.2 Sq. In. N.F.A./Ft.
- Length: 12'
- Exposure: 12"
- 20 Pcs./Ctn.
- 240 Sq Ft./Ctn.
- 68 Lbs./Ctn.

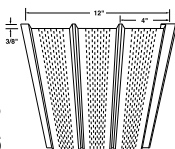

ECONOMY ALUMINUM SOFFIT

Product Code/Description

Color Availability

SAS12313

**Economy
Triple 4" Solid
U-Groove Soffit**

- Finish: Alupalure 2000®
- Nominal Thickness: .013
- Length: 12'
- Exposure: 12"
- 20 Pcs./Ctn.
- 240 Sq Ft./Ctn.
- 56 Lbs./Ctn.

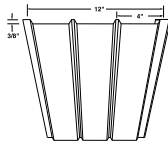

White

LCAS12313

**Economy
Triple 4" Center Lanced
U-Groove Soffit**

- Finish: Alupalure 2000®
- Nominal Thickness: .013
- 4.4 Sq. In. N.F.A./Ft.
- Length: 12'
- Exposure: 12"
- 20 Pcs./Ctn.
- 240 Sq Ft./Ctn.
- 56 Lbs./Ctn.

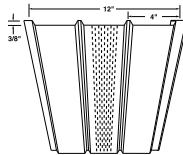

LFAS12313

**Economy
Triple 4" Full Lanced
U-Groove Soffit**

- Finish: Alupalure 2000®
- Nominal Thickness: .013
- 13.2 Sq. In. N.F.A./Ft.
- Length: 12'
- Exposure: 12"
- 20 Pcs./Ctn.
- 240 Sq Ft./Ctn.
- 56 Lbs./Ctn.

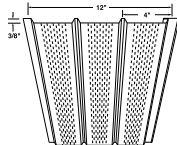

ECONOMY ALUMINUM SOFFIT

Product Code/Description

Color Availability

LFAS16413

**Economy
Quad 4" Full Lanced
U-Groove Soffit**

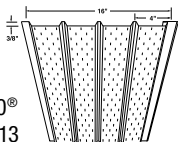

- Finish: Alupalure 2000®
- Nominal Thickness: .013
- 5.16 Sq. In. N.F.A./Ft.
- Length: 12'
- Exposure: 16'
- 18 Pcs./Ctn.
- 288 Sq Ft./Ctn.
- 65.25 Lbs./Ctn.

White
Royal Brown
Dark Bronze

SAS16413

**Economy
Quad 4" Solid
U-Groove Soffit**

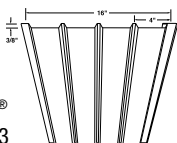

- Finish: Alupalure 2000®
- Nominal Thickness: .013
- 5.16 Sq. In. N.F.A./Ft.
- Length: 12'
- Exposure: 16'
- 18 Pcs./Ctn.
- 288 Sq Ft./Ctn.
- 65.25 Lbs./Ctn.

White
Royal Brown
Dark Bronze

ALUMINUM FASCIA

Product Code/Description

Color Availability

F1C425
Envoy Smooth
4" Fascia Trim

- Finish: Alupalure 2000®
- Nominal Thickness: .024
- Length: 12'
- 25 Pcs./Ctn.
- 41 Lbs./Ctn.

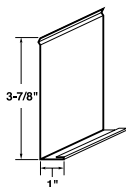

- | | |
|------------------|--------------|
| White | Terra Bronze |
| Black | Wicker |
| Almond | |
| Cameo | |
| Dark Bronze | |
| Desert Sand | |
| Evergreen | |
| Linen | |
| Montana Suede | |
| Musket Brown | |
| Pebblestone Clay | |
| Royal Brown | |
| Sandtone | |

F1C625
Envoy Smooth
6" Fascia Trim

- Finish: Alupalure 2000®
- Nominal Thickness: .024
- Length: 12'
- 25 Pcs./Ctn.
- 55 Lbs./Ctn.

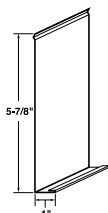

- | |
|------------------|
| White |
| Black |
| Almond |
| Cameo |
| Charcoal Grey |
| Classic Cream |
| Dark Bronze |
| Desert Sand |
| Everest |
| Evergreen |
| Harbor Grey |
| Linen |
| Montana Suede |
| Musket Brown |
| Pebblestone Clay |
| Royal Brown |
| Rugged Canyon |
| Sandtone |
| Silver Grey |
| Terra Bronze |
| Victorian Grey |
| Wicker |

F1C825
Envoy Smooth
8" Fascia Trim

- Finish: Alupalure 2000®
- Nominal Thickness: .024
- Length: 12'
- 25 Pcs./Ctn.
- 71 Lbs./Ctn.

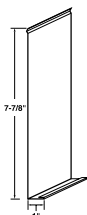

- | |
|------------------|
| White |
| Almond |
| Cameo |
| Dark Bronze |
| Desert Sand |
| Linen |
| Musket Brown |
| Pebblestone Clay |
| Terra Bronze |
| Wicker |

F1C1025
Envoy Smooth
10" Fascia Trim

- Finish: Alupalure 2000®
- Nominal Thickness: .024
- Length: 12'
- 25 Pcs./Ctn.
- 85 Lbs./Ctn.

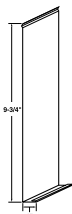

Optional
aluminum
fascia covers

ALUMINUM FASCIA

Product Code/Description

Color Availability

F1C4SR02425

Envoy Ribbed 4" Fascia Trim

- Finish: Alupalure 2000®
- Nominal Thickness: .024
- Length: 12'
- 25 Pcs./Ctn.
- 41 Lbs./Ctn.

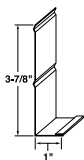

White	Pebblestone Clay
Black	Royal Brown
Almond	Sandtone
Cameo	Terra Bronze
Dark Bronze	Wicker
Desert Sand	
Evergreen	
Linen	
Montana Suede	
Musket Brown	

F1C6SR02425

Envoy Ribbed 6" Fascia Trim

- Finish: Alupalure 2000®
- Nominal Thickness: .024
- Length: 12'
- 25 Pcs./Ctn.
- 55 Lbs./Ctn.

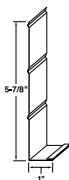

White
Black
Almond
Cameo
Charcoal Grey
Classic Cream
Dark Bronze
Desert Sand
Evergreen
Harbor Grey
Linen
Montana Suede
Musket Brown
Pebblestone Clay
Royal Brown
Rugged Canyon
Sandtone
Silver Grey
Terra Bronze
Victorian Grey
Wicker

F1C8SR02425

Envoy Ribbed 8" Fascia Trim

- Finish: Alupalure 2000®
- Nominal Thickness: .024
- Length: 12'
- 25 Pcs./Ctn.
- 71 Lbs./Ctn.

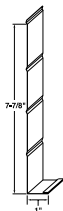

White
Almond
Cameo
Dark Bronze
Desert Sand
Linen
Musket Brown
Pebblestone Clay
Terra Bronze
Wicker

F1C10SR02425

Envoy Ribbed 10" Fascia Trim

- Finish: Alupalure 2000®
- Nominal Thickness: .024
- Length: 12'
- 25 Pcs./Ctn.
- 85 Lbs./Ctn.

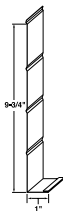

ALUMINUM FASCIA

Product Code/Description

Color Availability

F1C4SR25

**Endurance Ribbed
4" Fascia Trim**

- Finish: Alumalure 2000®
- Nominal Thickness: .019
- Length: 12'
- 25 Pcs./Ctn.
- 35 Lbs./Ctn.

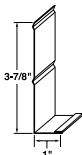

- White
- Almond
- Cameo
- Dark Bronze
- Desert Sand
- Linen
- Musket Brown
- Pebblestone Clay
- Royal Brown
- Terra Bronze
- Wicker

F1C6SR25

**Endurance Ribbed
6" Fascia Trim**

- Finish: Alumalure 2000®
- Nominal Thickness: .019
- Length: 12'
- 25 Pcs./Ctn.
- 47 Lbs./Ctn.

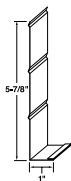

- White
- Black
- Almond
- Cameo
- Charcoal Grey
- Classic Cream
- Dark Bronze
- Desert Sand
- Evergreen
- Linen
- Montana Suede
- Musket Brown
- Pebblestone Clay
- Royal Brown
- Rugged Canyon
- Sandtone
- Terra Bronze
- Wicker

F1C8SR25

**Endurance Ribbed
8" Fascia Trim**

- Finish: Alumalure 2000®
- Nominal Thickness: .019
- Length: 12'
- 25 Pcs./Ctn.
- 59 Lbs./Ctn.

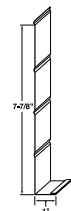

- White
- Almond
- Cameo
- Dark Bronze
- Desert Sand
- Musket Brown
- Pebblestone Clay
- Terra Bronze
- Wicker

F1C10SR25

**Endurance Ribbed
10" Fascia Trim**

- Finish: Alumalure 2000®
- Nominal Thickness: .019
- Length: 12'
- 25 Pcs./Ctn.
- 72 Lbs./Ctn.

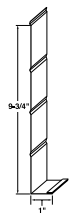

- White
- Almond
- Classic Cream
- Wicker

GRT6SR12

**Gable Rake
6" Fascia Trim**

- Finish: Alumalure 2000®
- Nominal Thickness: .019
- Length: 12'
- 12 Pcs./Ctn.
- 27 Lbs./Ctn.

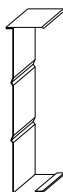

PLY GEM PERFORMANCE METALS

ALUMINUM FASCIA

Product Code/Description

Color Availability

F1C4025

**Envoy Wood Grain Embossed
4" Fascia Trim**

- Finish: Alumalure 2000®
- Nominal Thickness: .024
- Length: 12'
- 25 Pcs./Ctn.
- 41 Lbs./Ctn.

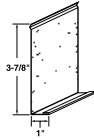

White
Black
Almond
Cameo
Dark Bronze
Desert Sand
Evergreen
Linen
Montana Suede
Musket Brown
Pebblestone Clay

Royal Brown
Sandtone
Terra Bronze
Wicker

F1C6025

**Envoy Wood Grain
Embossed
6" Fascia Trim**

- Finish: Alumalure 2000+
- Nominal Thickness: .024
- Length: 12'
- 25 Pcs./Ctn.
- 55 Lbs./Ctn.



White
Black
Almond
Cameo
Charcoal Grey
Classic Cream
Dark Bronze
Desert Sand
Evergreen
Harbor Grey
Linen
Montana Suede
Musket Brown
Pebblestone Clay
Royal Brown
Rugged Canyon
Sandtone
Silver Grey
Terra Bronze
Victorian Grey
Wicker

F1C8025

**Envoy Wood Grain
Embossed
8" Fascia Trim**

- Finish: Alumalure 2000®
- Nominal Thickness: .024
- Length: 12'
- 25 Pcs./Ctn.
- 71 Lbs./Ctn.

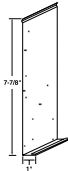

White
Almond
Cameo
Dark Bronze
Desert Sand
Linen
Musket Brown
Pebblestone Clay
Terra Bronze
Wicker

F1C10025

**Envoy Wood Grain Embossed
10" Fascia Trim**

- Finish: Alumalure 2000®
- Nominal Thickness: .024
- Length: 12'
- 25 Pcs./Ctn.
- 85 Lbs./Ctn.

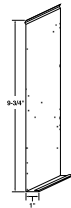

ALUMINUM SOFFIT AND FASCIA ACCESSORIES

Product Code/Description

Color Availability

4APN20

General Purpose Trim

- Finish: Alumalure 2000®
- Nominal Thickness: .019
- Length: 12' 6"
- 20 Pcs./Ctn.
- 14.3 Lbs./Ctn.

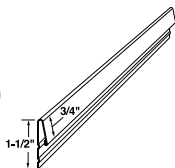

- | | |
|---------------|------------------|
| White | Musket Brown |
| Black | Pebblestone Clay |
| Almond | Royal Brown |
| Cameo | Rugged Canyon |
| Charcoal Grey | Sandtone |
| Classic Cream | Terra Bronze |
| Dark Bronze | Victorian Grey |
| Desert Sand | Wicker |
| Evergreen | |
| Linen | |
| Montana Suede | |

F438

J-Channel - 3/8" 1" Face, Offset

- Finish: Alumalure 2000®
- Nominal Thickness: .019
- Length: 12' 1"
- 40 Pcs./Ctn.
- 42 Lbs./Ctn.

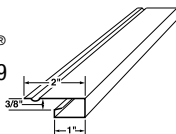

- | | |
|---------------|------------------|
| White | Musket Brown |
| Black | Pebblestone Clay |
| Almond | Royal Brown |
| Cameo | Rugged Canyon |
| Charcoal Grey | Sandtone |
| Classic Cream | Silver Grey |
| Dark Bronze | Terra Bronze |
| Desert Sand | Victorian Grey |
| Evergreen | Wicker |
| Harbor Grey | |
| Linen | |
| Montana Suede | |

Use: 3/8" Soffit

F438425

J-Channel - 3/8" 3/4" Face

- Finish: Alumalure 2000®
- Nominal Thickness: .016
- Length: 12' 0"
- 25 Pcs./Ctn.
- 19 Lbs./Ctn.

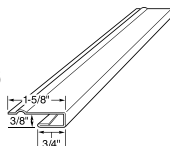

- | | |
|------------------|----------------|
| White | Royal Brown |
| Black | Rugged Canyon |
| Almond | Sandtone |
| Cameo | Silver Grey |
| Charcoal Grey | Terra Bronze |
| Classic Cream | Victorian Grey |
| Dark Bronze | Wicker |
| Desert Sand | |
| Everest | |
| Evergreen | |
| Harbor Grey | |
| Linen | |
| Montana Suede | |
| Musket Brown | |
| Pebblestone Clay | |

Use: 3/8" Soffit

ALUMINUM SOFFIT AND FASCIA ACCESSORIES

Product Code/Description

Color Availability

SJ1625

J-Channel - 1/2"

3/4" Face

- Finish: Alupalure 2000®
- Nominal Thickness: .016
- Length: 12' 0"
- 25 Pcs./Ctn.
- 18 Lbs./Ctn.

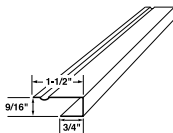

Use: 1/2" Soffit

White
Black
Almond
Cameo
Classic Cream
Dark Bronze
Desert Sand
Evergreen
Linen
Musket Brown
Pebblestone Clay

Royal Brown
Rugged Canyon
Sandtone
Silver Grey
Terra Bronze
Wicker

58ALJ25

J-Channel - 5/8"

1" Face

- Finish: Alupalure 2000®
- Nominal Thickness: .019
- Length: 12'
- 25 Pcs./Ctn.
- 22.5 Lbs./Ctn.

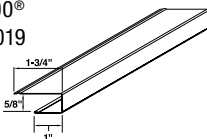

Note: For use with 5/8" vinyl soffit

White
Almond
Cameo
Charcoal Grey
Classic Cream
Desert Sand
Everest
Harbor Grey
Linen
Montana Suede
Musket Brown

Pebblestone Clay
Rugged Canyon
Sandtone
Silver Grey
Victorian Grey
Wicker

78ALJ25

J-Channel - 7/8"

- Finish: Alupalure 2000®
- Nominal Thickness: .019
- Length: 12'
- 25 Pcs./Ctn.
- 26 Lbs./Ctn.

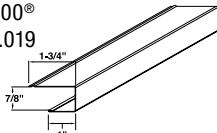

Note: For use with 5/8" or 3/4" vinyl siding and soffit.

White
Almond
Cameo
Classic Cream
Desert Sand
Linen
Montana Suede
Pebblestone Clay
Sandtone
Wicker

SAT38

T-Channel - 3/8"

1 1/4" Face

- Finish: Alupalure 2000®
- Nominal Thickness: .019
- Length: 10'
- 10 Pcs./Ctn.
- 14 Lbs./Ctn.

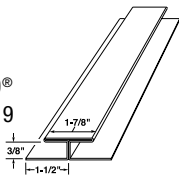

White
Black
Almond
Cameo
Classic Cream
Dark Bronze
Desert Sand
Evergreen
Linen
Montana Suede

Musket Brown
Pebblestone Clay
Royal Brown
Rugged Canyon
Sandtone
Silver Grey
Terra Bronze
Wicker

ALUMINUM SOFFIT AND FASCIA ACCESSORIES

Product Code/Description

Color Availability

F8S25

F-Channel - 3/8"

1-1/4" Face

- Finish: Alupalure 2000®
- Nominal Thickness: .019
- Length: 12'
- 25 Pcs./Ctn.
- 37 Lbs./Ctn.

Use: 3/8" Soffit

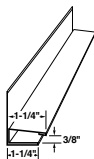

White
Black
Almond
Cameo
Charcoal Grey
Classic Cream
Dark Bronze
Desert Sand
Everest
Evergreen
Harbor Grey
Linen
Montana Suede
Musket Brown
Pebblestone Clay

Royal Brown
Rugged Canyon
Sandtone
Silver Grey
Terra Bronze
Victorian Grey
Wicker

F12

F-Channel - 1/2"

5/8" Face

- Finish: Alupalure 2000®
- Nominal Thickness: .019
- Length: 12' 0"
- 25 Pcs./Ctn.
- 20 Lbs./Ctn.

Use: 1/2" Soffit

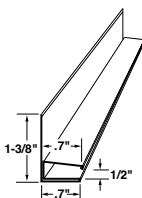

White
Musket Brown

SF1625

F-Channel - 1/2"

1" Face

- Finish: Alupalure 2000®
- Nominal Thickness: .019
- Length: 12'
- 25 Pcs./Ctn.
- 37 Lbs./Ctn.

Use: 1/2" Soffit

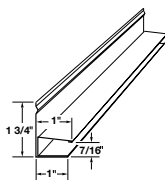

White
Almond
Cameo
Desert Sand
Linen
Musket Brown
Pebblestone Clay
Royal Brown
Sandtone
Silver Grey
Terra Bronze
Wicker

SF58

F-Channel - 5/8"

1" Face

- Finish: Alupalure 2000®
- Nominal Thickness: .019
- Length: 12' 1"
- 24 Pcs./Ctn.
- 38 Lbs./Ctn.

For use with 5/8" Vinyl Soffit

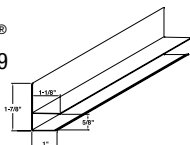

White
Almond
Cameo
Pebblestone Clay
Wicker

ALUMINUM SOFFIT AND FASCIA ACCESSORIES

Product Code/Description

WBTU

Touch-Up Paint

- (Bottled with brush)
- 1 Oz./Plastic Bottles
- 6/Ctn.
- 0.9 Lb./Ctn.



TN1250

#15 Stainless Steel Trim Nails - 1-1/4"

- 1 Lb./Ctn.

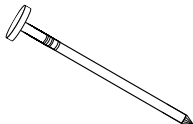

Color Availability

- | | |
|------------------|----------------|
| Black | Rugged Canyon |
| Almond | Sandtone |
| Cameo | Silver Grey |
| Charcoal Grey | Terra Bronze |
| Classic Cream | Victorian Grey |
| Dark Bronze | Wicker |
| Desert Sand | White |
| Everest | |
| Evergreen | |
| Harbor Grey | |
| Linen | |
| Montana Suede | |
| Musket Brown | |
| Pebblestone Clay | |
| Royal Brown | |

ROOF AND EAVE VENTILATION PRODUCTS

Product Code/Description

Color Availability

VAR

Vent-A-Ridge®

- Aluminum
- Length: 10'
- 12 Pcs./Ctn.
- 18 Sq. In. Net Free Ventilation/Ln. Ft.
- 52 Lbs./Ctn.

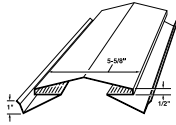

White
Black
Musket Brown

VAREP36

End Plug for VAR

- Solid Polymer
- 36 Pcs./Ctn.
- 5 Lbs./Ctn.

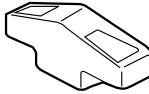

Black

VAS70

Vent-A-Strip (Model 70)

- Aluminum
- Length: 8'
- 36 Pcs./Ctn.
- 8.8 Sq. In. Net Free Ventilation/Ln. Ft.
- 29 Lbs./Ctn.

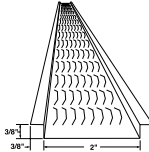

Mill

White
Musket Brown

VAS79

Vent-A-Strip (Model 79)

- Aluminum
- Length: 8'
- 36 Pcs./Ctn.
- 9.9 Sq. In. Net Free Ventilation/Ln. Ft.
- 33 Lbs./Ctn.

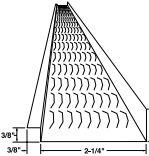

GUTTER COIL

Description	Product Code	Thickness (nominal)	Width	Nominal Length	Target Coil Weight (+/-50 Lbs.)	Fl./Lb. Conversion	Color Availability
Gutter Coil One-Side Finish Coat • 16" Center I.D.	GC11750	.027	11.750"	950	350	2.713	30° White (Medium Gloss)
	GC1175032	.032	11.750"	825	350	2.36	80° White (High Gloss)
	GC11875	.027	11.875"	940	350	2.684	Black
	GC1187532	.032	11.875"	820	350	2.306	Almond
	GC1300032	.032	13.000"	750	350	2.133	Cameo
	GC15000	.027	15.000"	750	350	2.125	Charcoal Grey
	GC1500032	.032	15.000"	650	350	1.849	Classic Cream
							Dark Bronze
						Desert Sand	
						Evergreen	
						Jefferson Tan	
						Linen	
						Montana Suede	
						Musket Brown	
						Pebblestone Clay	
						Royal Brown	
						Rugged Canyon	
						Sandtone	
						Silver Grey	
						Terra Bronze	
						Victorian Grey	
						Wicker	

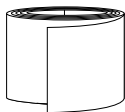

Extended Lead Time Colors

Everest
Harbor Grey

*These colors are only available in .032" and does not include 13"

DOWNSPOUT COIL

Description	Product Code	Thickness (nominal)	Width	Weight Target (Lbs.)	Color Availability
2 x 3 Downspout Coil <ul style="list-style-type: none"> • 16" Center I.D. • 3615' per Roll/appx. • 750# = 3615' appx. 	DC10500	.019	10.500"	(±75)	30° White (Medium Gloss) 80° White (High Gloss) Black Almond Cameo Charcoal Grey Classic Cream Dark Bronze Desert Sand Evergreen Jefferson Tan Linen Montana Suede Musket Brown Pebblestone Clay Royal Brown Sandtone Terra Bronze Victorian Grey Wicker
				750	
3 x 4 Downspout Coil <ul style="list-style-type: none"> • 16" Center I.D. • 1000 lb. = 3680' appx. • 500 lb. = 1840' appx. 	DC13750 DC1375500	.019	13.750"	(±75)	30° White (Medium Gloss) 80° White (High Gloss) Black Almond Cameo Charcoal Grey Classic Cream Dark Bronze Desert Sand Evergreen Jefferson Tan Linen Montana Suede Musket Brown Pebblestone Clay Royal Brown Sandtone Terra Bronze Victorian Grey Wicker
				1000 500	

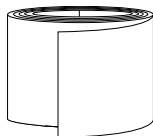
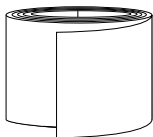

GUTTER ACCESSORIES

Product Code/Description

Color Availability

IBM5

5" Inside Box Miter

- Nominal Thickness: .019
- 20 Pcs./Ctn.
- 8 Lbs./Ctn.

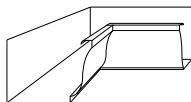

30° White (Medium Gloss)

80° White (High Gloss)

Black
Almond
Cameo
Charcoal Grey
Classic Cream
Dark Bronze
Desert Sand
Everest
Evergreen
Harbor Grey
Jefferson Tan
Linen
Montana Suede
Musket Brown
Pebblestone Clay
Royal Brown
Rugged Canyon
Sandtone
Silver Grey
Terra Bronze
Victorian Grey
Wicker

OBM5

5" Outside Box Miter

- Nominal Thickness: .019
- 20 Pcs./Ctn.
- 8 Lbs./Ctn.

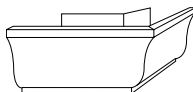

ISM5

5" Inside Strip Miter

- Nominal Thickness: .032
- 20 Pcs./Ctn.
- 2.2 Lbs./Ctn.



OSM5

5" Outside Strip Miter

- Nominal Thickness: .032
- 20 Pcs./Ctn.
- 2.3 Lbs./Ctn.



*Not available in OBM5

*Not available in OSM5

*Not available in IBM5 or ISM5

GUTTER ACCESSORIES

Product Code/Description

Color Availability

ISBAY5

5" Inside 45° Bay Miter

- Nominal Thickness: .032
- 12 Pcs./Ctn.
- 1.1 Lbs./Ctn.



30° White
(Medium Gloss/Paintable)
80° White
(High Gloss)
Black
Almond
Cameo
Dark Bronze
Musket Brown
Pebblestone Clay
Royal Brown
Wicker

OSBAY5

5" Outside 45° Bay Miter

- Nominal Thickness: .032
- 12 Pcs./Ctn.
- 1.1 Lbs./Ctn.

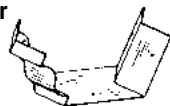

EC5L

5" Left End Caps

- Nominal Thickness: .019
- 50 Pcs./Ctn.
- 2.6 Lbs./Ctn.



30° White
(Medium Gloss)
80° White
(High Gloss)
Black
Almond
Cameo
Charcoal Grey
Classic Cream
Dark Bronze
Desert Sand
Everest
Evergreen
Harbor Grey
Jefferson Tan
Linen
Montana Suede
Musket Brown
Pebblestone Clay
Royal Brown
Rugged Canyon
Sandtone
Silver Grey
Terra Bronze
Victorian Grey
Wicker

EC5R

5" Right End Caps

- Nominal Thickness: .019
- 50 Pcs./Ctn.
- 2.6 Lbs./Ctn.



GUTTER ACCESSORIES

Product Code/Description

Color Availability

IBM6

6" Inside Box Miter

- Nominal Thickness: .019
- 20 Pcs./Ctn.
- 13 Lbs./Ctn.

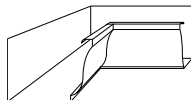

30° White (Medium Gloss)

80° White (High Gloss)

Black
Almond
Cameo
Charcoal Grey
Classic Cream
Dark Bronze
Desert Sand
Everest
Evergreen
Harbor Grey
Jefferson Tan
Linen
Montana Suede
Musket Brown
Pebblestone Clay
Royal Brown
Rugged Canyon
Sandtone
Silver Grey
Terra Bronze
Victorian Grey
Wicker

OBM6

6" Outside Box Miter

- Nominal Thickness: .019
- 20 Pcs./Ctn.
- 12 Lbs./Ctn.

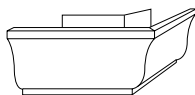

ISM6

6" Inside Strip Miter

- Nominal Thickness: .032
- 20 Pcs./Ctn.
- 3.4 Lbs./Ctn.



OSM6

6" Outside Strip Miter

- Nominal Thickness: .032
- 20 Pcs./Ctn.
- 3.2 Lbs./Ctn.

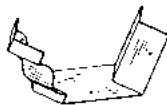

*Not available in OBM6

**Not available in OSM6

GUTTER ACCESSORIES

Product Code/Description

ISBAY6

6" Inside 45° Bay Miter

- Nominal Thickness: .032
- 12 Pcs./Ctn.
- 2 Lbs./Ctn.



OSBAY6

6" Outside 45° Bay Miter

- Nominal Thickness: .032
- 12 Pcs./Ctn.
- 2 Lbs./Ctn.

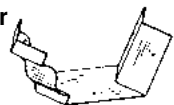

EC6L

6" Left End Caps

- Nominal Thickness: .019
- 50 Pcs./Ctn.
- 3.6 Lbs./Ctn.



EC6R

6" Right End Caps

- Nominal Thickness: .019
- 50 Pcs./Ctn.
- 3.6 Lbs./Ctn.



Color Availability

30° White
(Medium Gloss/Paintable)
80° White
(High Gloss)
Black
Almond
Cameo
Dark Bronze
Musket Brown
Pebblestone Clay
Royal Brown
Wicker

30° White
(Medium Gloss)
80° White
(High Gloss)
Black
Almond
Cameo
Classic Cream
Charcoal Grey
Dark Bronze
Desert Sand
Everest
Evergreen
Harbor Grey
Jefferson Tan

Linen
Montana Suede
Musket Brown
Pebblestone Clay
Royal Brown
Rugged Canyon
Sandtone
Silver Grey
Terra Bronze
Victorian Grey
Wicker

GUTTER ACCESSORIES

Product Code/Description

Color Availability

ROT2X3

Outlet Tubes

- 2" x 3" Rectangular
- 30 Pcs./Ctn.
- 1.9 Lbs./Ctn.

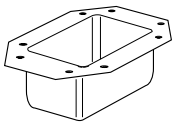

Mill Finish

ROT3X4

Outlet Tubes

- 3" x 4" Rectangular
- 50 Pcs./Ctn.
- 3.9 Lbs./Ctn.

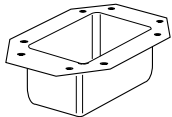

GUTTER AND DOWNSPOUT COIL ACCESSORIES

Product Code/Description

Color Availability

AM5HID

Aluminum 5" Hidden Hanger

- Nominal Thickness: .065
- 100 Pcs./Ctn.
- 6 Lbs./Ctn.

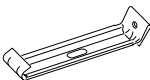

Mill Finish

AM5ZIP500

Aluminum 5" Zip Hanger

- 500 Pcs./Ctn.
- 37 Lbs./Ctn.

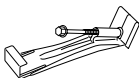

Mill Finish

AM6ZIP

Aluminum 6" Zip Hanger

- 50 Pcs./Ctn.
- 5 Lbs./Ctn.

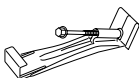

Mill Finish

GS50Z

Gutter Seal

- 24 Tubes./Ctn.
- 8 Lbs./Ctn.
- 5 oz.

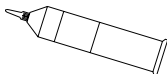

Mill Finish

GSW40Z J1

Gutter Seal

- 12 Tubes./Ctn.
- 3.75 Lbs./Ctn.
- 4 oz.

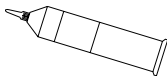

White

ASDIV

Valley Water Diverter

- 30 Pcs./Ctn.
- 1.6 Lbs./Ctn.

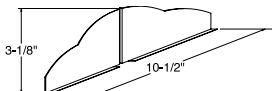

White

DOWNSPOUTS AND ACCESSORIES

Product Code/Description

DS2X3

2" x 3" Downspout

Length: 10'

- Nominal Thickness: .019
- 10 Pcs./Ctn.
- 26 Lbs./Ctn.

Note: Minimum order-one carton.

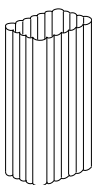

Color Availability

30° White
(Medium Gloss)
80° White
(High Gloss)
Black
Almond
Cameo
Charcoal Grey
Classic Cream
Dark Bronze
Desert Sand
Evergreen
Harbor Grey
Jefferson Tan
Linen
Montana Suede
Musket Brown
Pebblestone Clay
Royal Brown
Rugged Canyon
Sandtone
Silver Grey
Terra Bronze
Victorian Grey
Wicker

E2X3A

2" x 3" Elbow, Style A

- Nominal Thickness: .019
- 30 Pcs./Ctn.
- 7 Lbs./Ctn.

Note: Minimum order-one carton.



75°

E2X3B

2" x 3" Elbow, Style B

- Nominal Thickness: .019
- 30 Pcs./Ctn.
- 7 Lbs./Ctn.

Note: Minimum order-one carton.

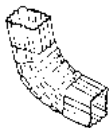

75°

Extended Lead Time Colors

Everest

*Not available in DS2x3A & DS2x3B

**Not available in DS2x3

DOWNSPOUTS AND ACCESSORIES

Product Code/Description

E2X3A30

2" x 3" Elbow, 30° Style A

- Nominal Thickness: .019
- 30 Pcs./Ctn.
- 7 Lbs./Ctn.

Use: short overhang / ledges

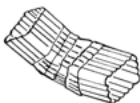

Color Availability

30° White
(Medium Gloss)
80° White
(High Gloss)
Black
Almond
Cameo
Classic Cream
Dark Bronze
Desert Sand
Evergreen

Linen
Musket Brown
Pebblestone Clay
Royal Brown
Sandtone
Terra Bronze
Victorian Grey
Wicker

DS2X38

2" x 3" Downspout

- Nominal Thickness: .019
- Length: 8'
- 10 Pcs./Ctn.
- 20 Lbs./Ctn.

Note: Minimum order-one carton.

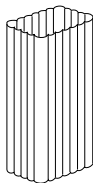

30° White
(Medium Gloss)

DOWNSPOUTS AND ACCESSORIES

Product Code/Description

Color Availability

LEDGE152X3
2" x 3" Downspout
with 1.5" Offset

- Nominal Thickness: .019
- 25 Pcs./Ctn.
- 6 Lbs./Ctn.

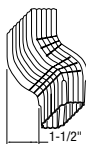

- 30° White (Medium Gloss)
- 80° White (High Gloss)
- Musket Brown
- Pebblestone Clay

LEDGE302X3
2" x 3" Downspout
with 3" Offset

- Nominal Thickness: .019
- 20 Pcs./Ctn.
- 6 Lbs./Ctn.

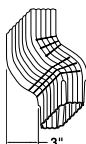

- 30° White (Medium Gloss)
- 80° White (High Gloss)

DS3X4
3" x 4" Downspout

- Nominal Thickness: .019
- Length: 10'
- 10 Pcs./Ctn.
- 34 Lbs./Ctn.

Note: Minimum order-one carton.

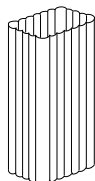

- Black
- Almond
- Cameo
- Charcoal Grey
- Classic Cream
- Dark Bronze
- Desert Sand
- Evergreen
- Harbor Grey
- Jefferson Tan
- Linen
- Montana Suede
- Musket Brown
- Pebblestone Clay
- Royal Brown
- Rugged Canyon
- Sandtone
- Silver Grey
- Terra Bronze
- Victorian Grey
- Wicker

E3X4A
3" x 4" Elbow, Style A

- Nominal Thickness: .019
- 20 Pcs./Ctn.
- 7 Lbs./Ctn.

Note: Minimum order-one carton.



Extended Lead Time Colors
 Everest

E3X4B
3" x 4" Elbow, Style B

- Nominal Thickness: .019
- 20 Pcs./Ctn.
- 8 Lbs./Ctn.

Note: Minimum order-one carton.



DOWNPOUTS AND ACCESSORIES

Product Code/Description

Color Availability

E3X4A30

3" x 4" Elbow, 30° Style A

- Nominal Thickness: .019
- 20 Pcs./Ctn.
- 8 Lbs./Ctn.

Use: short overhang / ledges

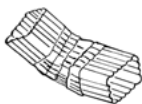

30° White
(Medium Gloss)
80° White
(High Gloss)
Black
Almond
Cameo
Classic Cream
Dark Bronze
Desert Sand

Evergreen
Linen
Musket Brown
Pebblestone Clay
Royal Brown
Sandtone
Terra Bronze
Victorian Grey
Wicker

DS3X48

3" x 4" Downspout

- Nominal Thickness: .019
- Length: 8'
- 10 Pcs./Ctn.
- 29 Lbs./Ctn.

Note: Minimum order-one carton.

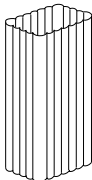

30° White
(Medium Gloss)

LEDGE203X4

3" x 4" Downspout with 2" Offset

- Nominal Thickness: .019
- 12 Pcs./Ctn.
- 5.5 Lbs./Ctn.

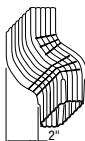

30° White
(Medium Gloss)
80° White
(High Gloss)
Musket
Pebblestone Clay

LEDGE403X4

3" x 4" Downspout with 4" Offset

- Nominal Thickness: .019
- 12 Pcs./Ctn.
- 5.7 Lbs./Ctn.

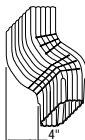

LEDGE603X4

3" x 4" Downspout with 6" Offset

- Nominal Thickness: .019
- 12 Pcs./Ctn.
- 6.5 Lbs./Ctn.



GUTTER AND DOWNSPOUT COIL ACCESSORIES

Product Code/Description

DPB

Downspout Pipe Band -Universal

- (Fits 2" x 3" or 3" x 4" Downspout)
- 100 Pcs./Ctn.
- Packaged Flat
- 3.6 Lbs./Ctn.



GR1

1/8" Bind Pop Rivets*

- 100 Pcs./Bag
- 10 Bags/Box
- 1.25 Lbs./Box



* Not available in J0 or J1.

GZS8

#8 x 1/2" Zip Screws

- 100 Pcs./Bag
- 10 Bags/Ctn.
- 3.8 Lbs./Ctn.



GCTU

Touch Up Paint (Aerosol)

- 12 Ozs./Can
- 12 Cans/Ctn.
- 12.6 Lbs./Ctn.

* Extended Lead Time.



GCTU1

Touch Up Paint (Aerosol Single Can)

- 12 Ozs./Can
- 1 Can/Ctn.
- 1.2 Lb./Ctn.

* Extended Lead Time.



Color Availability

30° White (Medium Gloss)	Pebblestone Clay
80° White (High Gloss)	Royal Brown
Black	Rugged Canyon
Almond	Sandtone
Cameo	Silver Grey
Charcoal Grey	Terra Bronze
Classic Cream	Victorian Grey
Dark Bronze	Wicker
Desert Sand	
Everest	
Evergreen	
Harbor Grey	
Jefferson Tan*	
Linen	
Montana Suede	
Musket Brown	

*Not available in DPB

*Not available in GCTU & GCTU1

METAL ACCESSORIES PROGRAM

FOR FIBER CEMENT

James Hardie Colors

Category	Product Code	Description	Color Availability
Soffit	SAS12316	Endurance T4 Soffit Solid	J0/04 White
	LCAS12316	Endurance T4 Soffit Center Vent	620 Autumn Tan
			625 Khaki Brown
	LFAS12316	Endurance T4 Soffit Full Vent	A5 Monterey Taupe
F438425	3/8" J-Channel	53 Navajo Beige (Almond)	
			A8 Sail Cloth
			297 Sandstone Beige
			581 Woodstock Brown

7" RAINWARE PROGRAM

Product Code/Description

Color Availability

Gutter Coil

GC17875

.027" X 17.875"

Gutter Coil

- Nominal Thickness: .027
- 450 Lbs./Roll
- 2 Ro/Pallet

30° White
(Medium Gloss)

80° White
(High Gloss)

Black
Almond
Cameo
Classic Cream
Dark Bronze
Desert Sand
Linen
Montana Suede
Musket Brown
Pebblestone Clay
Royal Brown
Sandtone
Wicker

Gutter Accessories

ISM7

7" Inside Strip Miter

OSM7

7" Outside Strip Miter

- 20 Pcs./Ctn.
- 4.2 Lbs./Ctn.

EC7L

7" Left End Cap

EC7R

7" Right End Cap

- 50 Pcs./Ctn.
- 4.5 Lbs./Ctn.

Downspouts, Elbows and Accessories

DS4X5

4" x 5" x 10'

Downspout

- Nominal
Thickness: .027
- 6 Pcs./Ctn.
- 35 Lbs./Ctn.

E4X5A

4" x 5" A Elbow

E4X5B

4" x 5" B Elbow

- Nominal
Thickness: .027
- 9 Pcs./Ctn.
- 7 Lbs./Ctn.

AM7ZIP 01

7" Zip Hangers

- 250 Pcs./Ctn.
- 30 Lbs./Ctn.

AM7HID 01

7" Hidden Hangers

- 350 Pcs./Ctn.
- 18 Lbs./Ctn.

OT4X5 01

4" x 5" Outlet Tube

- 10 Pcs./Ctn.
- 1 Lbs./Ctn.

SN7200S 00

**7" Leaf Relief Combo
Hanger w/Screws**

- 7' 6" Length
- 200 Screws/Ctn.
- 24 Pcs./Ctn.
- 47 Lbs./Ctn.

ROUND DOWNSPOUT PROGRAM

Product Code/Description

Color Availability

Downspout, Elbow, Offsets

DSR4

4" Smooth Round Downspout

- Nominal Thickness: .024
- 5 Pcs./Ctn.
- 21 Lbs./Ctn.



30° White
(Medium Gloss)
Black
Dark Bronze

ESR4

4" Smooth Round Elbow 75°

- Nominal Thickness: .024
- 20 Pcs./Ctn.
- 11 Lbs./Ctn.



OSR420

4" Smooth Round - 2' Offset

- Nominal Thickness: .024
- 10 Pcs./Ctn.
- 5 Lbs./Ctn.

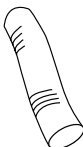

OSR440

4" Smooth Round - 4' Offset

- Nominal Thickness: .024
- 10 Pcs./Ctn.
- 6 Lbs./Ctn.

ENVOY® SECTIONAL GUTTER

5" GUTTER AND ACCESSORIES

Product Code/Description

Color Availability

OG16A

Envoy Sectional 5" OG Gutter

- Nominal Thickness: .032
- Length: 16'
- 10 Pcs./Ctn.
- 160'/Ctn.
- 80 Lbs./Ctn.

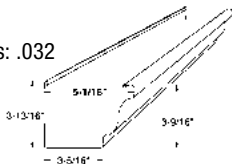

- 80° White
(High Gloss)
Almond
Desert Sand
Evergreen
Musket Brown
Pebblestone Clay
Sandtone
Terra Bronze
Victorian Grey

OG21A

Envoy Sectional 5" OG Gutter

- Nominal Thickness: .032
- Length: 21'
- 10 Pcs./Ctn.
- 210'/Ctn.
- 105 Lbs./Ctn.

OG26

Envoy Sectional 5" OG Gutter

- Nominal Thickness: .032
- Length: 26'
- 6 Pcs./Ctn.
- 156'/Ctn.
- 81 Lbs./Ctn.

OG33A

Envoy Sectional 5" OG Gutter

- Nominal Thickness: .032
- Length: 33'
- 6 Pcs./Ctn.
- 198'/Ctn.
- 103 Lbs./Ctn.

OG37A

Envoy Sectional 5" OG Gutter

- Nominal Thickness: .032
- Length: 37'
- 6 Pcs./Ctn.
- 222'/Ctn.
- 115 Lbs./Ctn.

ENVOY® SECTIONAL GUTTER

5" GUTTER ACCESSORIES

Product Code/Description

Color Availability

OG155

5" End Caps

- Nominal Thickness: .024
- 25 R and 25 L
- 25 Sets./Ctn.
- 50 Pcs./Ctn.
- 3.3 Lbs./Ctn.

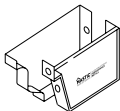

80° White
(High Gloss)
Almond
Desert Sand
Evergreen
Musket Brown

Pebblestone Gray
Sandtone
Terra Bronze
Victorian Grey

OG25

Neoprene Expansion Joint

- 12 Pcs./Ctn.
- 4 Lbs./Ctn.

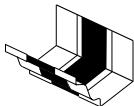

Mill

OG91

Snug-Fit Hanger

- Nominal Thickness: .081
- 100 Pcs./Ctn.
- 11.2 Lbs./Ctn.

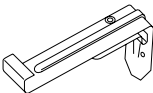

OG101

Combination Hanger

- Nominal Thickness: .081
- 100 Pcs./Ctn.
- 8.4 Lbs./Ctn.

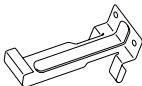

OG111

Strap Hanger

- Nominal Thickness: .081
- 100 Pcs./Ctn.
- 9.6 Lbs./Ctn.

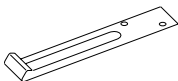

ENVOY® SECTIONAL GUTTER

5" GUTTER ACCESSORIES

Product Code/Description	Color Availability
<p>OG12R1 Bar Hanger</p> <ul style="list-style-type: none"> Nominal Thickness: .081 100 Pcs./Ctn. 7.4 Lbs./Ctn. 	<p>Mill</p>
<p>OG131 Roof Hanger</p> <ul style="list-style-type: none"> Nominal Thickness: .062 100 Pcs./Ctn. 13 Lbs./Ctn. 	<p>Mill</p>
<p>OG141 Combination Strap Hanger</p> <ul style="list-style-type: none"> Nominal Thickness: .081 100 Pcs./Ctn. 12 Lbs./Ctn. 	<p>Mill</p>
<p>RT312 Roof Apron, Rectangular</p> <ul style="list-style-type: none"> Nominal Thickness: .032 Length: 12' 20 Pcs./Ctn. 320'/Ctn. 47 Lbs./Ctn. 	<p>80° White (High Gloss) Almond Desert Sand Evergreen Musket Brown Pebblestone Clay Sandtone Terra Bronze Victorian Grey</p>
<p>RT412 Fascia Apron, Rectangular</p> <ul style="list-style-type: none"> Nominal Thickness: .032 Length: 12' 20 Pcs./Ctn. 240'/Ctn. 15 Lbs./Ctn. 	<p>80° White (High Gloss) Almond Desert Sand Evergreen Musket Brown Pebblestone Clay Sandtone Terra Bronze Victorian Grey</p>

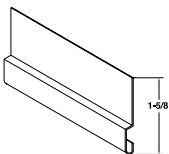
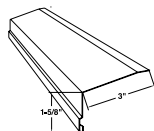

ENVOY® SECTIONAL GUTTER

6" GUTTER AND ACCESSORIES

Product Code/Description

Color Availability

OG21A6

Envoy Sectional 6" OG Gutter

- Nominal Thickness: .032
- Length: 21'
- 6 Pcs./Ctn.
- 126'/Ctn.
- 79 Lbs./Ctn.

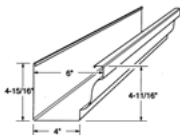

80° White
(High Gloss)
Almond
Desert Sand
Evergreen
Musket Brown
Pebblestone Clay
Sandtone
Terra Bronze
Victorian Grey

OG37A6

Envoy Sectional 6" OG Gutter

- Nominal Thickness: .032
- Length: 37'
- 4 Pcs./Ctn.
- 148'/Ctn.
- 95 Lbs./Ctn.

OG1565

6" End Caps

- Nominal Thickness: .024
- 25 Sets/Ctn.
- 50 Pcs./Ctn.
- 4.5 Lbs./Ctn.

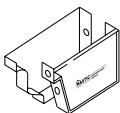



80° White
(High Gloss)
Almond
Desert Sand
Evergreen
Musket Brown

Pebblestone Clay
Sandtone
Terra Bronze
Victorian Grey

ENVOY[®] SECTIONAL GUTTER

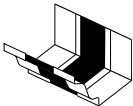
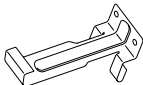
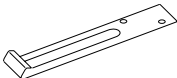
6" GUTTER AND ACCESSORIES

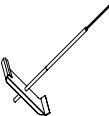
Product Code/Description		Color Availability
OG256 Neoprene Expansion Joint <ul style="list-style-type: none">• 12 Pcs./Ctn.• 5 Lbs./Ctn.		Mill
OG1061 Combination Hanger <ul style="list-style-type: none">• Nominal Thickness: .081• 100 Pcs./Ctn.• 9.4 Lbs./Ctn.		Mill
OG1161 Strap Hanger <ul style="list-style-type: none">• Nominal Thickness: .081• 100 Pcs./Ctn.• 11 Lbs./Ctn.		Mill
OG12R61 Bar Hanger <ul style="list-style-type: none">• Nominal Thickness: .081• 100 Pcs./Ctn.• 8.3 Lbs./Ctn.		Mill
OG1361 Roof Hanger <ul style="list-style-type: none">• Nominal Thickness: .062• 100 Pcs./Ctn.• 13 Lbs./Ctn.		Mill

ENVOY[®] SECTIONAL GUTTER

DOWNSPOUTS AND ACCESSORIES

Product Code/Description

Color Availability

RT34

3" x 4" Rectangular Corrugated Downspout

- Nominal Thickness: .024
- Length: 10'
- 10 Pcs./Ctn.
- 100'/Ctn.
- 43 Lbs./Ctn.

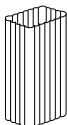

30° White
(Medium Gloss)
80° White
(High Gloss)
Almond
Desert Sand
Evergreen
Musket Brown
Pebblestone Clay
Sandtone
Terra Bronze
Victorian Grey

RTA74

3" x 4" Style "A" Rectangular Elbow

- Nominal Thickness: .024
- Degree: 75°
- 20 Pcs./Ctn.
- 9 Lbs./Ctn.



RTB74

3" x 4" Style "B" Rectangular Elbow

- Nominal Thickness: .024
- Degree: 75°
- 20 Pcs./Ctn.
- 10 Lbs./Ctn.

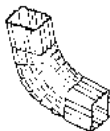

RTA3

Downspout Clip

- (For 3" x 4" Downspout)
- Nominal Thickness: .024
- 100 Pcs./Ctn.
- 2.8 Lbs./Ctn.

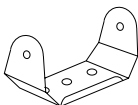

30° White
(Medium Gloss)
80° White
(High Gloss)
Black
Almond
Cameo
Classic Cream
Dark Bronze
Desert Sand

Evergreen
Linen
Musket Brown
Pebblestone Clay
Royal Brown
Sandtone
Terra Bronze
Victorian Grey
Wicker

ENVOY® SECTIONAL GUTTER

DOWNSPOUTS AND ACCESSORIES

Product Code/Description

Color Availability

RT2

2" x 3" Rectangular Corrugated Downspout

- Nominal Thickness: .024
- Length: 10' • 100'/Ctn.
- 10 Pcs./Ctn. • 33 Lbs./Ctn.

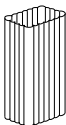

30° White
(Medium Gloss)
80° White
(High Gloss)
Almond
Desert Sand
Evergreen
Musket Brown
Pebblestone Clay
Sandtone
Terra Bronze
Victorian Grey

2" x 3" Style "A" Rectangular Elbow

RTA4 (80° White High Gloss
Only)

- Nominal Thickness: .024 • 30 Pcs./Ctn.
- Degree: 45° • 8 Lbs./Ctn.



RTA7

- Nominal Thickness: .024 • 30 Pcs./Ctn.
- Degree: 75° • 9 Lbs./Ctn.

RTB7

2" x 3" Style "B" Rectangular Elbow

- Degree: 75°
- Nominal Thickness: .024 • 30 Pcs./Ctn.
- 9 Lbs./Ctn.



R0T2X3

2" x 3" Rectangular Eave Tube

- Nominal Thickness: .024
- 30 Pcs./Ctn.
- 1.9 Lbs./Ctn.

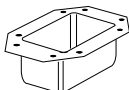

Mill

RTA2

Downspout Clip

- (For 2" x 3" Downspout)
- Nominal Thickness: .024
- 100 Pcs./Ctn.
- 1.7 Lbs./Ctn.

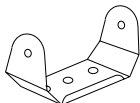

30° White
(Medium Gloss)
80° White
(High Gloss)
Black
Almond
Cameo
Classic Cream
Dark Bronze
Desert Sand

Evergreen
Linen
Musket Brown
Pebblestone Clay
Royal Brown
Sandtone
Terra Bronze
Victorian Grey
Wicker

RT235

Downspout Anchor Clip with Screw

- 50 Sets/Ctn.
- 3.2 Lbs./Ctn.

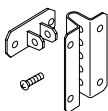

Mill

LEAF RELIEF® 5"

GUTTER PROTECTION SYSTEMS

Product Code/Description

Color Availability

D11500

33 Black

DuoPro 5" Dual Layer Microfiltration - Continuous Hanger

- Nominal Thickness: .019
- Length: 7' 6"
- 24 Pcs./Ctn.
- 180'/Ctn.
- 47 Lbs./Ctn.

Note: 200 screws/Ctn. Use Leaf Relief DuoPro 5" Dual Layer Universal Corner or Access Panel Kit UA11500.

UA11500

DuoPro 5" Dual Layer Microfiltration Universal Inside/Outside Corner or Access Panel Kit

- Nominal Thickness: .019
- 10 Corners or 20 Access Panels/Ctn
- 5 Lbs./Ctn.

Note: Use with D11500 DuoPro 5" Dual Layer Microfiltration Continuous Hanger. Universal Inside/Outside/Access Panel functions as either one corner or two Access Panels.

Leaf Relief



SN5200S

00 Mill Finish

5" Continuous Hanger

- Nominal Thickness: .019
- Length: 7' 6"
- 48 Pcs./Ctn.
- 360'/Ctn.
- 59.4 Lbs./Ctn.

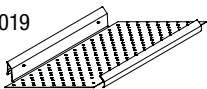

Note: 300 screws/Ctn. Use Leaf Relief corner kits OC5220/IC5220.

APSN52

5" Leaf Relief Access Panel

- Nominal Thickness: .019
- Length: 1' 6"
- 20 Pcs./Ctn.
- 30'/Ctn.
- 5.8 Lbs./Ctn.

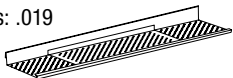

Leaf Relief CH
& DuoPro on
new gutters



LEAF RELIEF® 5"

GUTTER PROTECTION SYSTEMS

Product Code/Description

Color Availability

SN5200BG
**5" Box Gutter
Continuous Hanger**

- Length: 7' 6"
- 360/Ctn.
- 63 Lbs./Ctn.
- 300 screws included.

Note: Use Leaf Relief corner kit
UA5200BG Universal Inside/
Outside Corner Access Panel.

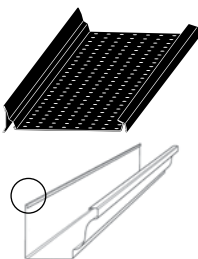

33 Black

UA5200BG
**5" Box Gutter Continuous Hanger
Universal Inside/Outside Corner/Access
Panel Kit**

- 10 Corners or 20 Access Panels/Ctn.
- 4 Lbs./Ctn.

TP5300

5" Classic

- Nominal Thickness: .019
- Length: 10'
- 32 Pcs./Ctn.
- 320/Ctn.
- 48.6 Lbs./Ctn.



00 Mill Finish

TP53ZIP

5" Zip

- Nominal Thickness: .019
- Length: 10'
- 32 Pcs./Ctn.
- 320/Ctn.
- 51.8 Lbs./Ctn.

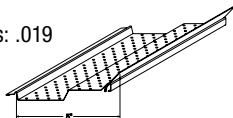

TP5100Q

5" Adjustable

- Nominal Thickness: .019
- Length: 7' 6"
- 16 Pcs./Ctn.
- 120/Ctn.
- 22 Lbs./Ctn.

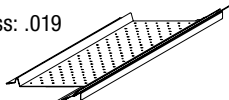

Installing classic
Leaf Relief on
existing gutters



LEAF RELIEF® 5"

GUTTER PROTECTION SYSTEMS

Product Code/Description

Color Availability

TPC5100

0C Copper

5" Adjustable Copper

- Nominal Thickness: .017
- Length: 7' 6"
- 16 Pcs./Ctn.
- 120'/Ctn.
- 71.6 Lbs./Ctn.
- 200 Copper screws included.

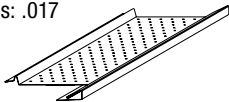

Use only with K or OG-style copper gutters.

* Special order. One Carton Minimum. Call for price and lead time.

HR5400

00 Mill Finish

5" Half-Round

- Nominal Thickness: .024
- Length: 7' 6"
- 16 Pcs./Ctn.
- 120'/Ctn. • 22.6 Lbs./Ctn.

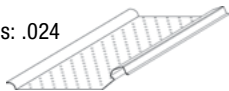

HRC5400

0C Copper

5" Half Round Copper

- Nominal Thickness: .017
- Length: 7' 6"
- 16 Pcs./Ctn.
- 120'/Ctn.
- 56.5 Lbs./Ctn.
- 200 Copper screws included.



Use only with 5" Half-Round copper gutters.

* Special order. One Carton Minimum. Call for price and lead time.

OC5220

00 Mill Finish

5" Outside Corners

- Nominal Thickness: .019
- 20 Complete Corners/Ctn.
- 3.4 Lbs./Ctn.

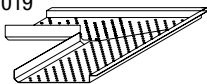

Use with SN5200S, TP5100Q, TP5300, TP53ZIP

IC5220

5" Inside Corners

- Nominal Thickness: .019
- 20 Complete Corners/Ctn.
- 3.4 Lbs./Ctn.

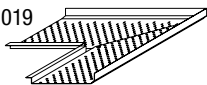

Use with SN5200S, TP5100Q, TP5300, TP53ZIP

LEAF RELIEF® 6"

GUTTER PROTECTION SYSTEMS

Product Code/Description

Color Availability

D11600

33 Black

DuoPro 6" Dual Layer Microfiltration - Continuous Hanger

- Nominal Thickness: .019
- Length: 7' 6"
- 24 Pcs./Ctn.
- 180'/Ctn.
- 200 screws included
- 54 Lbs./Ctn.

Note: Use Leaf Relief DuoPro 6" Dual Layer Universal Corner or Access Panel Kit UA11600. Universal Inside/Outside/Access Panel functions as either one corner or two Access Panels.

UA11600

DuoPro 6" Dual Layer Microfiltration Universal Inside/Outside Corner or Access Panel Kit

- Nominal Thickness: .019
- 10 Corners or 20 Access Panels/Ctn
- No screws included
- 5 Lbs./Ctn.

Note: Use with D11600 DuoPro 6" Dual Layer Microfiltration Continuous Hanger. Universal Inside/Outside/Access Panel functions as either one corner or two Access Panels.

SN6200S

00 Mill Finish

6" Continuous Hanger

- Nominal Thickness: .019
- Length: 7' 6"
- 34 Pcs./Ctn.
- 255'/Ctn.
- 49.4 Lbs./Ctn.

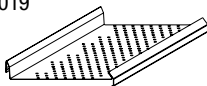

Note: 300 screws/Ctn. Use Leaf Relief corner kits 0C6220/IC6220

APSN62

00 Mill Finish

6" Leaf Relief Access Panel

- Nominal Thickness: .019
- Length: 1' 6"
- 20 Pcs./Ctn.
- 30'/Ctn.
- 6.6 Lbs./Ctn.

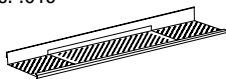

Leaf Relief CH
& DuoPro on
new gutters



LEAF RELIEF® 6"

GUTTER PROTECTION SYSTEMS

Product Code/Description

Color Availability

SN6200BG

33 Black

6" Box Gutter Continuous Hanger

- Nominal Thickness: .019
- Length: 7' 5"
- 34 Pcs./Ctn.
- 255'/Ctn.
- 300 screws included
- 71 Lbs./Ctn.

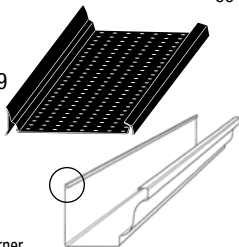

Note: use Leaf Relief Universal Corner or Access Panel Kit UA6200BG Universal Inside/Outside/Access Panel. Universal Inside/Outside/Access Panel either functions as one corner or two Access Panels.

UA6200BG

6" Box Gutter Universal Inside/Outside Corner or Access Panel Kit

- Nominal Thickness: .019
- 10 Corners or 20 Access Panels/Ctn
- No screws included
- 4 Lbs./Ctn.

Note: use with SN6200BG 6" Box Gutter Continuous Hanger.

TP6300

00 No Color

6" Classic

- Nominal Thickness: .019
- Length: 10'
- 32 Pcs./Ctn.
- 320'/Ctn.
- 55.4 Lbs./Ctn.



TP63ZIP

6" Zip

- Nominal Thickness: .019
- Length: 10'
- 32 Pcs./Ctn.
- 320'/Ctn.
- 57.6 Lbs./Ctn.

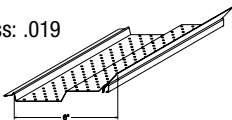

(For use over 0G1061, 0G12R61, zip hangers)

LEAF RELIEF® 6"

GUTTER PROTECTION SYSTEMS

Product Code/Description

Color Availability

TPC6100

0C Copper

6" Adjustable Copper

- Nominal Thickness: .017
- Length: 7' 6"
- 16 Pcs./Ctn.
- 120'/Ctn.
- 75.0 Lbs./Ctn.
- 200 Copper screws included.

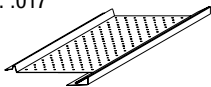

Use only with K or 0G-style copper gutters.

* Special Order. One Carton Minimum. Call for price and lead time.

HR6400

00 Mill Finish

6" Half Round

- Nominal Thickness: .024
- Length: 7' 6"
- 16 Pcs./Ctn.
- 120'/Ctn.
- 25.4 Lbs./Ctn.



HRC6400

0C Copper

6" Half Round Copper

- Nominal Thickness: .017
- Length: 7' 6"
- 16 Pcs./Ctn.
- 120'/Ctn.
- 63.0 Lbs./Ctn.
- 200 Copper screws included.



Use only with 6" Half-Round copper gutters.

OC6220

00 Mill Finish

6" Leaf Relief Outside Corners

- Nominal Thickness: .019
- 20 Complete Corners/Ctn.
- 3.8 Lbs./Ctn.

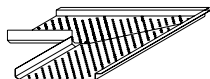

Use with: SN6200S, TP6300

IC6220

6" Leaf Relief Inside Corners

- Nominal Thickness: .019
- 20 Complete Corners/Ctn.
- 3.8 Lbs./Ctn.

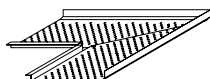

Use with: SN6200S, TP6300

LEAF RELIEF®

GUTTER PROTECTION SYSTEMS

Product Code/Description

Color Availability

SN7200S

00 No Color

**7" Leaf Relief Continuous
Hanger w/Screws**

- 7' 6" Length
- 200 Screws/Ctn.
- 24 Pcs./Ctn.
- 47 Lbs./Ctn.

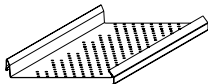

SC9X150

**#9 x 1-1/2" Hex-Head
Coated Screw
with Gasket**

- 1000/Ctn.
- 100/Pkg.
- 10 Pkg./Ctn.
- 11.5 Lbs./Ctn.



(For use with SN5200S, SN6200S, and SN7200S Systems)

SQ6X038

Mill Finish

**#6 x 3/8" Stainless Steel
Screw Pan Head
with Square Drive Slot**

- 1000/Ctn.
- 100/Pkg.
- 10 Pkg./Ctn.
- 2 Lbs./Ctn

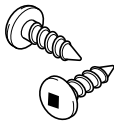

(For use with TP5100Q , TP5300, HR5400, HR6400,
and TP6300 Systems)

LEAF LOGIC™

GUTTER PROTECTION SYSTEMS

Product Code/Description

Color Availability

LL510

5" Rippled Plate

- Nominal
Thickness: .015
- Length: 10'
- 30 Pcs./Ctn.
- 300'/Ctn.
- 30 Lbs./Ctn.

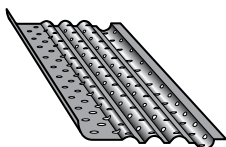

04 White
00 Mill Finish
JS Dark Bronze

LL610

6" Rippled Plate

- Nominal
Thickness: .015
- Length: 10'
- 30 Pcs./Ctn.
- 300'/Ctn.
- 35 Lbs./Ctn.

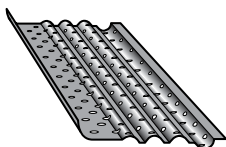

Leaf Smart™

Gutter Protection Systems

Product Code/Description

Color Availability

LS54

5" Steel Mesh

- Nominal
Thickness: .032
- Length: 4'
- 25 Pcs./Ctn.
- 100'/Ctn.
- 26 Lbs./Ctn.

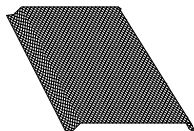

00 Mill Finish

LS64

6" Steel Mesh

- Nominal
Thickness: .032
- Length: 4'
- 25 Pcs./Ctn.
- 100'/Ctn.
- 28 Lbs./Ctn.

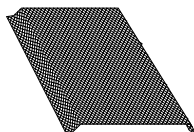

ROOFING ACCESSORIES

T-DRIP

Product Code	Description	Face Lgth	Top Lgth	Part Lgth	Material	Finish	Nominal Thickness/ Gauge	Pcs/ Ctn	Lbs/ Ctn
TD1029L	T-Drip 1x2-7/8 Light	1"	2-7/8"	10'	Aluminum	Alumalure 2000	0.013	25	15.8
Available Colors: White 04, Black 33, Musket Brown 59									
TD1029	T-Drip 1x2-7/8	1"	2-7/8"	10'	Aluminum	Alumalure 2000	0.016	25	19.2
Available Colors: White 04, Pebblestone Clay 52									
TD1029S	T-Drip 1x2-7/8 Galvanized	1"	2-7/8"	10'	Galvanized Steel	Polyester	0.016	25	51.1
Available Colors: Royal Brown 62									
TD1529	T-Drip 1-1/2x2-7/8	1-1/2"	2-7/8"	10'	Aluminum	Alumalure 2000	0.016	25	21.6
Available Colors: White 04, Black 33, Pebblestone Clay 52, Royal Brown 62									
TD1529H	T-Drip 1-1/2x2-7/8 Heavy	1-1/2"	2-7/8"	10'	Aluminum	Alumalure 2000	0.019	25	25.2
Available Colors: White 04, Black 33, Almond 53, Dark Bronze JS, Desert Sand 22, Musket Brown 59, Pebblestone Clay 52, Royal Brown 62, Terra Bronze 34, Wicker A7									
TD1529H12	T-Drip 1-1/2x2-7/8x12" Heavy	1-1/2"	2-7/8"	12'	Aluminum	Alumalure 2000	0.019	25	30.3
Available Colors: White 04, Black 33, Almond 53, Cameo 31, Charcoal Grey 80, Dark Bronze JS, Desert Sand 22, Evergreen 70, Linen 44, Musket Brown 59, Pebblestone Clay 52, Royal Brown 62, Sandtone 39, Terra Bronze 34, Wicker A7									
TD1829	T-Drip 1-3/4x2-7/8	1-3/4"	2-7/8"	10'	Aluminum	Alumalure 2000	0.016	25	22.5
Available Colors: White 04, Black 33, Almond 53, Dark Bronze JS, Musket Brown 59, Pebblestone Clay 52, Royal Brown 62, Wicker A7, A5 Monterey Taupe									
TD1829H	T-Drip 1-3/4x2-7/8 Heavy	1-3/4"	2-7/8"	10'	Aluminum	Alumalure 2000	0.019	25	26.4
Available Colors: Almond 53, Cameo 31, Charcoal Grey 80, Dark Bronze JS, Desert Sand 22, Evergreen 70, Musket Brown 59, Pebblestone Clay 52, Royal Brown 62, Terra Bronze 34, Wicker A7, White 04, Black 33, Monterey Taupe A5									
TD2029H	T-Drip 2x2-7/8 Heavy	2"	2-7/8"	10'	Aluminum	Alumalure 2000	0.019	25	28.3
Available Colors: White 04									

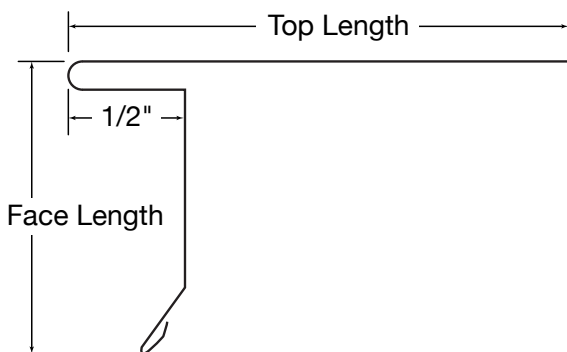

ROOFING ACCESSORIES

T-DRIP

Product Code	Description	Face Lgth	Top Lgth	Part Lgth	Material	Finish	Nominal Thickness/ Gauge	Pcs/ Ctn	Lbs/ Ctn
TD1029L	T-Drip 1x2-7/8 Light	1"	2-7/8"	10'	Aluminum	Alumalure 2000	0.013	25	15.8
Available Colors: White 04, Black 33, Musket Brown 59									
TD1029	T-Drip 1x2-7/8	1"	2-7/8"	10'	Aluminum	Alumalure 2000	0.016	25	19.2
Available Colors: White 04, Pebblestone Clay 52									
TD1029S	T-Drip 1x2-7/8 Galvanized	1"	2-7/8"	10'	Galvanized Steel	Polyester	0.016	25	51.1
Available Colors: Royal Brown 62									
TD1529	T-Drip 1-1/2x2-7/8	1-1/2"	2-7/8"	10'	Aluminum	Alumalure 2000	0.016	25	21.6
Available Colors: White 04, Black 33, Pebblestone Clay 52, Royal Brown 62									
TD1529H	T-Drip 1-1/2x2-7/8 Heavy	1-1/2"	2-7/8"	10'	Aluminum	Alumalure 2000	0.019	25	25.2
Available Colors: White 04, Black 33, Almond 53, Dark Bronze JS, Desert Sand 22, Musket Brown 59, Pebblestone Clay 52, Royal Brown 62, Terra Bronze 34, Wicker A7									
TD1529H12	T-Drip 1-1/2x2-7/8x12' Heavy	1-1/2"	2-7/8"	12'	Aluminum	Alumalure 2000	0.019	25	30.3
Available Colors: White 04, Black 33, Almond 53, Cameo 31, Charcoal Grey 80, Dark Bronze JS, Desert Sand 22, Evergreen 70, Linen 44, Musket Brown 59, Pebblestone Clay 52, Royal Brown 62, Sandtone 39, Terra Bronze 34, Wicker A7									
TD1829	T-Drip 1-3/4x2-7/8	1-3/4"	2-7/8"	10'	Aluminum	Alumalure 2000	0.016	25	22.5
Available Colors: White 04, Black 33, Almond 53, Dark Bronze JS, Musket Brown 59, Pebblestone Clay 52, Royal Brown 62, Wicker A7, A5 Monterey Taupe									
TD1829H	T-Drip 1-3/4x2-7/8 Heavy	1-3/4"	2-7/8"	10'	Aluminum	Alumalure 2000	0.019	25	26.4
Available Colors: Almond 53, Cameo 31, Charcoal Grey 80, Dark Bronze JS, Desert Sand 22, Evergreen 70, Musket Brown 59, Pebblestone Clay 52, Royal Brown 62, Terra Bronze 34, Wicker A7, White 04, Black 33, Monterey Taupe A5									
TD2029H	T-Drip 2x2-7/8 Heavy	2"	2-7/8"	10'	Aluminum	Alumalure 2000	0.019	25	28.3
Available Colors: White 04									

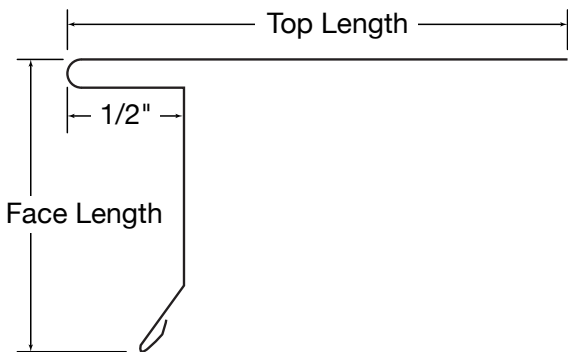

ROOFING ACCESSORIES

SQUARE DRIP / GUTTER APRON

Product Code	Description	Face Lgth	Top Lgth	Part Lgth	Material	Finish	Nominal Thickness/ Gauge	Pcs/ Ctn	Lbs/ Ctn
SD1515H	Sq Drip 1-1/2x1-1/2 Heavy	1-1/2"	1-1/2"	10'	Aluminum	Alumalure 2000	0.019	25	20.5

Available Colors: White 04

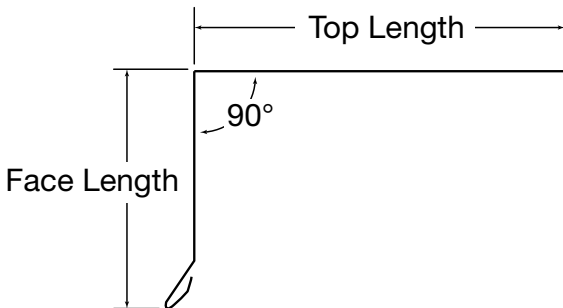

Product Code	Description	Face Lgth	Top Lgth	Part Lgth	Material	Finish	Nominal Thickness/ Gauge	Pcs/ Ctn	Lbs/ Ctn
GA2029H	Apron 2x2-7/8" Heavy	2"	2-7/8"	10'	Aluminum	Alumalure 2000	0.019	25	25.2

Available Colors: White 04, Black 33, Almond 53, Dark Bronze JS, Musket Brown 59, Pebblestone Clay 52, Royal Brown 62, Terra Bronze 34, Wicker A7

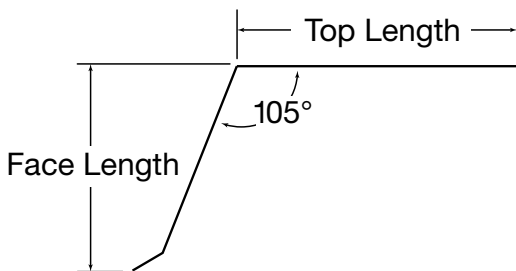

ROOFING ACCESSORIES

QUICK DRIP / GRAVEL STOP

Product Code	Description	Face Lgth	Top Lgth	Part Lgth	Material	Finish	Nominal Thickness/ Gauge	Pcs/ Ctn	Lbs/ Ctn
QD2410H12	Quick Drip 2-7/16x1x12' Heavy	2-7/16"	1"	12'	Aluminum	Alumalure 2000	0.019	25	20.5

Available Colors: White 04, Black 33, Almond 53, Cameo 31

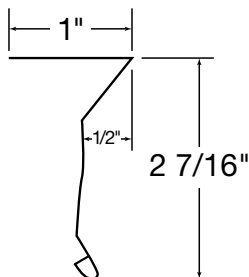

Product Code	Description	Face Lgth	Top Lgth	Part Lgth	Material	Finish	Nominal Thickness/ Gauge	Pcs/ Ctn	Lbs/ Ctn
GS4040XH	Gravel Stop 4x4 Extra Heavy	4"	4"	10'	Aluminum	Alumalure 2000	0.024	25	25.2

Available Colors: White 04, Black 33, Dark Bronze JS, Musket Brown 59, Pebblestone Clay 52, Royal Brown 62, Terra Bronze 34, A5 Monterey Taupe

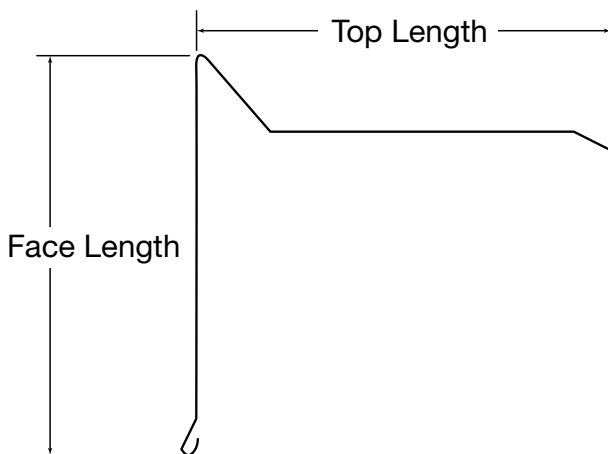

ROOFING ACCESSORIES

F-DRIP

Product Code	Description	Face Lgth	Top Lgth	Part Lgth	Material	Finish	Nominal Thickness/ Gauge	Pcs/ Ctn	Lbs/ Ctn
FD1060H	F-Drip 1x6 Heavy	1"	6"	10'	Aluminum	Alumalure 2000	0.019	25	35.5
Available Colors: White 04									
FD202012	F-Drip 2x2	2"	2"	12'	Aluminum	Alumalure 2000	0.016	25	23
Available Colors: White 04, Black 33, Musket Brown 59, Pebblestone Clay 52									
FD2020H12	F-Drip 2x2x12' Heavy	2"	2"	12'	Aluminum	Alumalure 2000	0.019	25	27
Available Colors: White 04									
FD2028	F-Drip 2x2-3/4	2"	2-3/4"	10'	Aluminum	Alumalure 2000	0.016	25	22.5
Available Colors: White 04									
FD2028H	F-Drip 2x2-3/4 Heavy	2"	2-3/4"	10'	Aluminum	Alumalure 2000	0.019	25	26.5
Available Colors: White 04, Almond 53, Charcoal Grey 80, Desert Sand 22, Linen 44, Musket Brown 59, Sandtone 39, Victorian Grey 36									
FD2028S	F-Drip 2x2-3/4 Galvanized	2"	2-3/4"	10'	Galvanized Steel	Polyester	0.016	25	59.9
Available Colors: Mill 00, White 04, Black 33, Almond 53, Pebblestone Clay 52, Royal Brown 62, Terra Bronze 34									

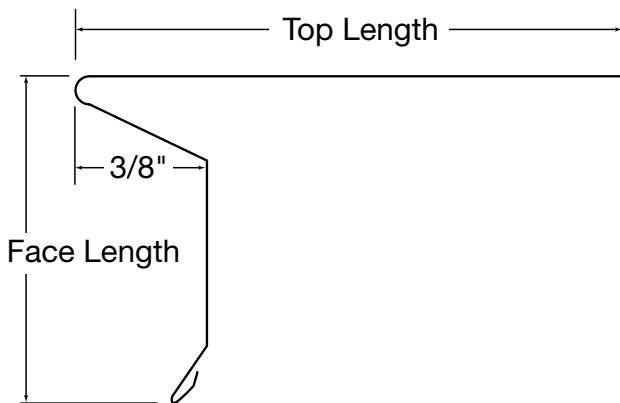

ROOFING ACCESSORIES

C DRIP

Product Code	Description	Face Lgth	Top Lgth	Bottom Lgth	Part Lgth	Material	Finish	Nominal Thickness/ Gauge	Pcs/ Ctn	Lbs/ Ctn
CD1028H	C-Drip 1x2-3/4 Heavy	1"	2-3/4"	1-1/8"	10'	Aluminum	Alumalure 2000	0.019	25	26.4

Available Colors: White 04

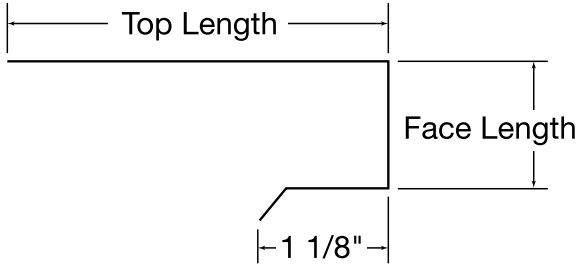

BUILDREADY/TRIM

5/8

Trim Board

(5/8" actual)

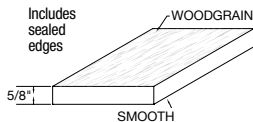
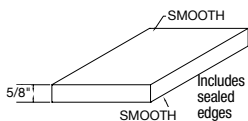

(Protective Film Top Side)

18" Lengths	Smooth	Woodgrain	Selling UOM	Pieces/Selling Unit	Skid Length (Feet)	Skid Width (Feet)	Skid Height (Inches)
5/8" x 4	27845001	27848001	Unit	130	18	4	11.5
5/8" x 6	27845002	27848002	Unit	80	18	4	11.5
5/8" x 8	27845003	27848003	Unit	60	18	4	11.5
5/8" x 10	27845004	27848004	Unit	50	18	4	11.5
5/8" x 12	27845005	27848005	Unit	40	18	4	11.5
5/8" x 16	27845078	27848078	Unit	30	18	4	11.5

4/4

Trim Board

(3/4" actual)

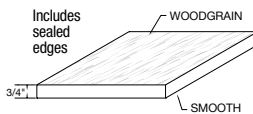
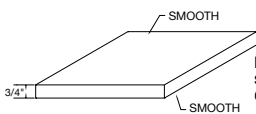

(Protective Film Top Side)

12' Offering	Smooth	Woodgrain	Selling UOM	Pieces/Selling Unit	Skid Length (Feet)	Skid Width (Feet)	Skid Height (Inches)
1 x 4	27845146	27848146	Unit	104	12	4	11.1
1 x 6	27845147	27848147	Unit	64	12	4	11.1
1 x 8	27845148	27848148	Unit	48	12	4	11.1
1 x 10	27845149	27848149	Unit	40	12	4	11.1
1 x 12	27845150	27848150	Unit	32	12	4	11.1

18' Offering	Smooth	Woodgrain	Selling UOM	Pieces/Selling Unit	Skid Length (Feet)	Skid Width (Feet)	Skid Height (Inches)
1 x 4	27845006	27848006	Unit	104	18	4	11.1
1 x 6	27845009	27848009	Unit	64	18	4	11.1
1 x 8	27845010	27848010	Unit	48	18	4	11.1
1 x 10	27845011	27848011	Unit	40	18	4	11.1
1 x 12	27845012	27848012	Unit	32	18	4	11.1
1 x 16	27845377	27848377	Unit	24	18	4	11.1

20" Offering	Smooth	Woodgrain	Selling UOM	Pieces/Selling Unit	Skid Length (Feet)	Skid Width (Feet)	Skid Height (Inches)
1 x 3	27845519	27848519	Unit	114	20	4	9.6
1 x 4	27845513	27848513	Unit	104	20	4	11.1
1 x 6	27845514	27848514	Unit	64	20	4	11.1
1 x 8	27845515	27848515	Unit	48	20	4	11.1
1 x 10	27845516	27848516	Unit	40	20	4	11.1
1 x 12	27845517	27848517	Unit	32	20	4	11.1
1 x 16	27845518	27848518	Unit	24	20	4	11.1

Trim Board measurements are nominal. All Sheet and 5/8" Trim Board measurements are actual. Please see our website for more detailed information.

5/4

Trim Board

(1" actual)

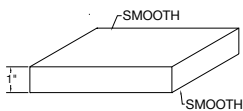

Includes sealed edges

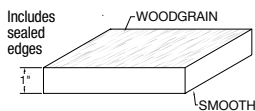

(Protective Film Top Side)

12' Offering	Smooth	Woodgrain	Selling UOM	Pieces/ Selling Unit	Skid Length (Feet)	Skid Width (Feet)	Skid Height (Inches)
5/4 x 4	27845156	27848156	Unit	78	12	4	11
5/4 x 6	27845157	27848157	Unit	48	12	4	11
5/4 x 8	27845158	27848158	Unit	36	12	4	11
5/4 x 10	27845187	27848187	Unit	30	12	4	11
5/4 x 12	27845208	27848208	Unit	24	12	4	11

18' Offering	Smooth	Woodgrain	Selling UOM	Pieces/ Selling Unit	Skid Length (Feet)	Skid Width (Feet)	Skid Height (Inches)
5/4 x 4	27845013	27848013	Unit	78	18	4	11
5/4 x 5	27845503	27848503	Unit	70	18	4	12
5/4 x 6	27845015	27848015	Unit	48	18	4	11
5/4 x 8	27845016	27848016	Unit	36	18	4	11
5/4 x 10	27845017	27848017	Unit	30	18	4	11
5/4 x 12	27845018	27848018	Unit	24	18	4	11
5/4 x 16	27845527	27848527	Unit	18	18	4	11

20' Offering	Smooth	Woodgrain	Selling UOM	Pieces/ Selling Unit	Skid Length (Feet)	Skid Width (Feet)	Skid Height (Inches)
5/4 x 4	27845072	27848072	Unit	78	20	4	11
5/4 x 6	27845074	27848074	Unit	48	20	4	11
5/4 x 8	27845075	27848075	Unit	36	20	4	11
5/4 x 10	27845076	27848076	Unit	30	20	4	11
5/4 x 12	27845077	27848077	Unit	24	20	4	11
5/4 x 16	27845405	27848405	Unit	18	20	4	11



**PVC TRIM OFFERINGS
AND ACCESSORIES**

**BENDING
PVC TRIM**



**INSTALLING
PVC TRIM**

**HOW TO CLEAN,
FINISH & PAINT
PVC TRIM**



BUILDDREADY/ACCESSORIES

Specialty Offerings

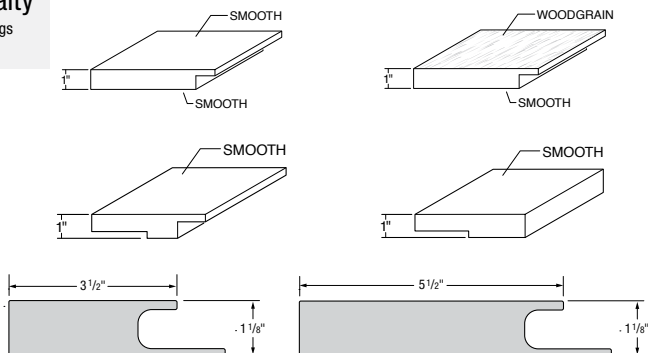

18' Offering	Smooth	Woodgrain	Selling UOM	Pieces/Selling Unit	Skid Length (Feet)	Skid Width (Feet)	Skid Height (Inches)
5/4 x 4 w/J-Pocket	27845528-P	27848528-P	Unit	78	18	4	11.25
			Ply Pak	3	non-skid	non-skid	non-skid
5/4 x 4 Flange	27845529-P	n/a	Unit	78	18	4	11.25
			Ply Pak	2	non-skid	non-skid	non-skid
5/4 x 4 Flange w/J-Pocket	27845530-P	n/a	Unit	78	18	4	11.25
			Ply Pak	2	non-skid	non-skid	non-skid
5/4 x 5 w/J-Pocket	27845531-P	27848531-P	Unit	70	18	4	12.25
			Ply Pak	2	non-skid	non-skid	non-skid
5/4 x 6 w/J-Pocket	27845532-P	27848532-P	Unit	48	18	4	9.25
			Ply Pak	2	non-skid	non-skid	non-skid
1 x 4 J-Pocket Casing w/nail fin (16' length)	27845569-MB	n/a	Bundle	4	non-skid	non-skid	non-skid
1 x 6 J-Pocket Casing w/nail fin (12' length)	27845570-MB	n/a	Bundle	4	non-skid	non-skid	non-skid

Note: PlyPaks contain multiple pieces shrink wrapped for easy handling and protection from dirt and marks.



**Bending
PVC trim**

**How to clean,
finish & paint
PVC trim**



Trim Board measurements are nominal. All Sheet and 5/8" Trim Board measurements are actual. Please see our website for more detailed information.

5/4

Corners

(1" thickness)

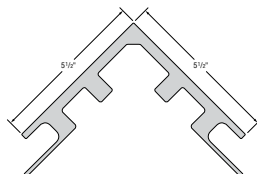
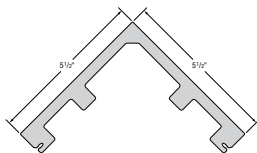
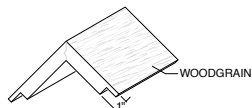
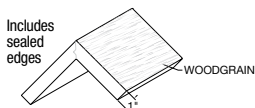
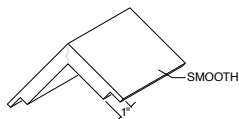
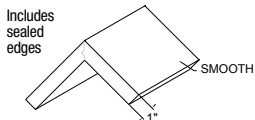

(This item has flexible nail fin not shown in illustration)

20' Offering	Smooth	Woodgrain	Selling UOM	Pieces/Selling Unit	Skid Length (Feet)	Skid Width (Feet)	Skid Height (Inches)
4 X 4	27845117-P	27848117-P	Unit	48	20	4	19.25
			Ply Pak	1	non-skid	non-skid	non-skid
4 x 4 w/J-Pocket	27845533-P	27848533-P	Unit	48	20	4	19.25
			Ply Pak	1	non-skid	non-skid	non-skid
6 X 6	27845118-P	27848118-P	Unit	32	20	4	27.25
			Ply Pak	1	non-skid	non-skid	non-skid
6 x 6 with J-Pocket	27845534-P	27848534-P	Unit	32	20	4	27.25
			Ply Pak	1	non-skid	non-skid	non-skid
6 x 6 Outside Corner w/nail fin	27845567-MB	n/a	Bundle	3	non-skid	non-skid	non-skid
6 x 6 Outside J-Pocket Corner w/nail fin	27845568-MB	n/a	Bundle	3	non-skid	non-skid	non-skid

Note: PlyPaks contain multiple pieces shrink wrapped for easy handling and protection from dirt and marks.

BUILDREADY/ACCESSORIES

5/4

Skirtboard

(1" thickness)

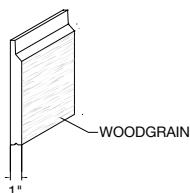
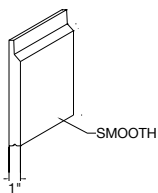

20' Offering	Smooth	Woodgrain	Selling UOM	Pieces/Selling Unit	Skid Length (Feet)	Skid Width (Feet)	Skid Height (Inches)
4" (face dimension 2-1/8")	27845535-P	27848535-P	Unit	96	18	4	13.25
			Ply Pak	2	non-skid	non-skid	non-skid
6" (face dimension 4-1/8")	27845536-P	27848536-P	Unit	36	18	4	13.25
			Ply Pak	2	non-skid	non-skid	non-skid
8" (face dimension 5-7/8")	27845537-P	27848537-P	Unit	30	18	4	10.25
			Ply Pak	2	non-skid	non-skid	non-skid

Specialty Offerings

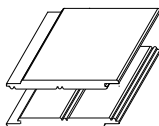

5" Beadboard

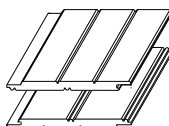

6" Beadboard

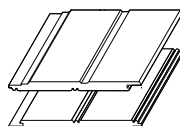

Moulded Beadboard

18' Offering	Smooth	Woodgrain	Selling UOM	Pieces/Selling Unit	Skid Length (Feet)	Skid Width (Feet)	Skid Height (Inches)
5" (installed coverage - 4.9")	27845600-P	n/a	Unit	96	18	4	13.25
			Ply Pak	6	non-skid	non-skid	non-skid
6" (installed coverage - 6")	27845063-P	n/a	Unit	96	18	4	13.25
			Ply Pak	4	non-skid	non-skid	non-skid
Moulded Beadboard (installed coverage - 5-1/2")	27845566-MB	n/a	Bundle	12	non-skid	non-skid	non-skid

Note: All Beadboard has smooth backing.

Trim Board measurements are nominal. All Sheet and 5/8" Trim Board measurements are actual. Please see our website for more detailed information.

Cortex

Fasteners

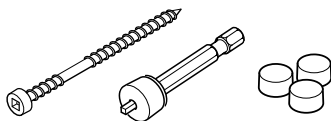

2" Length	Smooth	Woodgrain	Selling UOM	Pieces/ Selling Unit	Skid Length (Feet)	Skid Width (Feet)	Skid Height (Inches)
50 linear feet/ 75 screws	27845538-C	27848538-C	Carton	10	non-skid	non-skid	non-skid
250 linear feet/ 375 screws	27845539-C	27848539-C	Carton	6	non-skid	non-skid	non-skid
750 linear feet/ 1126 screws	27845540-C	27848540-C	Carton	1	non-skid	non-skid	non-skid
2" Length	Smooth	Woodgrain	Selling UOM	Pieces/ Selling Unit	Skid Length (Feet)	Skid Width (Feet)	Skid Height (Inches)
250 linear feet/ 375 screws	27845643-C	27848643-C	Carton	4	non-skid	non-skid	non-skid
2-3/4" Length	Smooth	Woodgrain	Selling UOM	Pieces/ Selling Unit	Skid Length (Feet)	Skid Width (Feet)	Skid Height (Inches)
50 linear feet/ 75 screws	27845612-C	27848612-C	Carton	-	non-skid	non-skid	non-skid
250 linear feet/ 375 screws	27845613-C	27848613-C	Carton	-	non-skid	non-skid	non-skid
750 linear feet/ 1126 screws	27845614-C	27848614-C	Carton	-	non-skid	non-skid	non-skid
2-3/4" Length	Smooth	Woodgrain	Selling UOM	Pieces/ Selling Unit	Skid Length (Feet)	Skid Width (Feet)	Skid Height (Inches)
250 linear feet/ 375 screws	27845644-C	27848644-C	Carton	-	non-skid	non-skid	non-skid
Plug only 40 PLG/Bag	27845645-C	27848645-C	Bag	400	non-skid	non-skid	non-skid

Note: PlyPaks contain multiple pieces shrink wrapped for easy handling and protection from dirt and marks.

Trim Board measurements are nominal. All Sheet and 5/8" Trim Board measurements are actual. Please see our website for more detailed information.

BUILDREADY/ACCESSORIES

One-Piece Post Wraps & Accessories

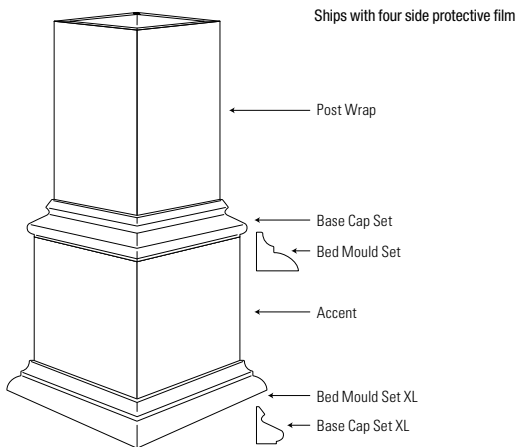

4 X 4 Nominal	Smooth	Selling UOM	Pieces/Selling Unit	Skid Length (Feet)	Skid Width (Feet)	Skid Height (Inches)
4 x 4 - 8'6" Length	27845541-C	Unit	48	9.0	3.75	25
		Carton	1	non-skid	non-skid	non-skid
4 x 4 - 10' Length	27845542-C	Unit	48	10.4	3.75	25
		Carton	1	non-skid	non-skid	non-skid
4 x 4 - Accent Wrap (12" length)	27845545-C	Carton	10	non-skid	non-skid	non-skid
4 x 4 - Bed Mould Set	27845543-C	Carton	20	non-skid	non-skid	non-skid
4 x 4 - Bed Mould Set XL	27845546-C	Carton	20	non-skid	non-skid	non-skid
4 x 4 - Base Cap Set	27845544-C	Carton	20	non-skid	non-skid	non-skid
4 x 4 - 4" Base Cap Set XL	27845547-C	Carton	20	non-skid	non-skid	non-skid
4X Belmont Post Cap	27845562-C	Carton	2	non-skid	non-skid	non-skid
4X Windsor Post Cap	27845563-C	Carton	1	non-skid	non-skid	non-skid
Basic Decor Kit (4 moulding sets & glue)	27845629-Kit	Kit	1	non-skid	non-skid	non-skid
Premium Decor Kit (5 moulding sets, 2 accents & glue)	27845630-Kit	Kit	1	non-skid	non-skid	non-skid

Trim Board measurements are nominal. All Sheet and 5/8" Trim Board measurements are actual. Please see our website for more detailed information.

One-Piece Post Wraps

& Accessories

Note: Bed and Base Cap sets are pre-mitered and dove-tailed for easy installation. "XL" indicates size to fit accents. Included in the basic kit: • 2 BedMolds • 2 Base Caps • Glue with tip. Included in the premium kit: • 2 Accent Wraps • 2 XL Bed Molds • 3 Base Caps • Glue with tip.

Trim Board measurements are nominal. All Sheet and 5/8" Trim Board measurements are actual. Please see our website for more detailed information.

6 X 6 Nominal	Smooth	Selling UOM	Pieces/Selling Unit	Skid Length (Feet)	Skid Width (Feet)	Skid Height (Inches)
6 x 6 - 8'6" Length	27845548-C	Unit	48	9.0	3.75	25
		Carton	1	non-skid	non-skid	non-skid
6 x 6 - 10' Length	27845549-C	Unit	48	10.4	3.75	25
		Carton	1	non-skid	non-skid	non-skid
6 x 6 - Accent Wrap (12" length)	27845552-C	Carton	10	non-skid	non-skid	non-skid
6 x 6 - Bed Mould Set	27845550-C	Carton	20	non-skid	non-skid	non-skid
6 x 6 - Bed Mould Set XL	27845553-C	Carton	20	non-skid	non-skid	non-skid
6 x 6 - Base Cap Set	27845551-C	Carton	20	non-skid	non-skid	non-skid
6 x 6 - Base Cap Set XL	27845554-C	Carton	20	non-skid	non-skid	non-skid
6X Belmont Post Cap	27845564-C	Carton	2	non-skid	non-skid	non-skid
6X Windsor Post Cap	27845565-C	Carton	1	non-skid	non-skid	non-skid
Basic Decor Kit (4 moulding sets & glue)	27845631-Kit	Kit	1	non-skid	non-skid	non-skid
Premium Decor Kit (5 moulding sets, 2 accents & glue)	27845632-Kit	Kit	1	non-skid	non-skid	non-skid
8 X 8 Nominal	Smooth	Selling UOM	Pieces/Selling Unit	Skid Length (Feet)	Skid Width (Feet)	Skid Height (Inches)
8 x 8 - 8' 6" Length	27845555-C	Unit	36	9.0	3.75	28
		Carton	1	non-skid	non-skid	non-skid
8 x 8 - 10'	27845556-C	Unit	36	10.4	3.75	28
		Carton	1	non-skid	non-skid	non-skid
8 x 8 Accent Wrap (12" length)	27845559-C	Carton	10	non-skid	non-skid	non-skid
Bed Mould Set	27845557-C	Carton	20	non-skid	non-skid	non-skid
Bed Mould Set XL	27845560-C	Carton	20	non-skid	non-skid	non-skid
Base Cap Mould Set	27845558-C	Carton	20	non-skid	non-skid	non-skid
Base Cap Set XL	27845561-C	Carton	20	non-skid	non-skid	non-skid
Glue with Tip	27845606-C	Carton	12	non-skid	non-skid	non-skid
Basic Decor Kit (4 moulding sets & glue)	27845633-Kit	Kit	1	non-skid	non-skid	non-skid
Premium Decor Kit (5 moulding sets, 2 accents & glue)	27845634-Kit	Kit	1	non-skid	non-skid	non-skid
10 X 10 Nominal	Smooth	Selling UOM	Pieces/Selling Unit	Skid Length (Feet)	Skid Width (Feet)	Skid Height (Inches)
10 x 10 - 8'6" Length	27845648-C	Unit	36	9	3.75	28
		Carton	1	non-skid	non-skid	non-skid
10 x 10 - 10' Length	27845568-C	Unit	36	10.4	3.75	28
		Carton	1	non-skid	non-skid	non-skid
10 x 10 - Accent Wrap (12" length)	27845652-C	Carton	10	non-skid	non-skid	non-skid
10 x 10 - Bed Mould Set	27845650-C	Carton	20	non-skid	non-skid	non-skid
10 x 10 - Bed Mould Set XL	27845653-C	Carton	20	non-skid	non-skid	non-skid
10 x 10 - Base Cap Set	27845651-C	Carton	20	non-skid	non-skid	non-skid
10 x 10 - Base Cap Set XL	27845654-C	Carton	20	non-skid	non-skid	non-skid

BUILDREADY/MOULDINGS

Brick Mould

Item Number	Length	Selling UOM	Pieces/Selling Unit	Skid Length (Feet)	Skid Width (Feet)	Skid Height (Inches)
27845573-MB	17'6"	Unit	252	18'	3.9	20.5
		Bundle	6	non-skid	non-skid	non-skid

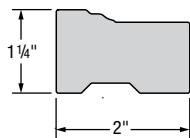

J Brick

Item Number	Length	Selling UOM	Pieces/Selling Unit	Skid Length (Feet)	Skid Width (Feet)	Skid Height (Inches)
27845574-MB	18'	Unit	240	18"	3.9	20.5
		Bundle	8	non-skid	non-skid	non-skid

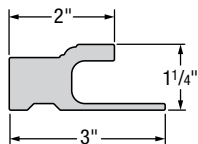

Brick Mould w/ nail fin for hard board nailing

Item Number	Length	Selling UOM	Pieces/Selling Unit	Skid Length (Feet)	Skid Width (Feet)	Skid Height (Inches)
27845575-MB	18'	Unit	240	18"	3.9	20.5
		Bundle	6	non-skid	non-skid	non-skid

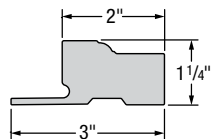

Base Cap

Item Number	Length	Selling UOM	Pieces/Selling Unit	Skid Length (Feet)	Skid Width (Feet)	Skid Height (Inches)
27845571-MB	16'	Unit	936	18"	3.9	20.5
		Bundle	36	non-skid	non-skid	non-skid

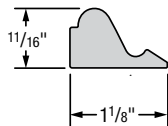

Bed Mould

Item Number	Length	Selling UOM	Pieces/Selling Unit	Skid Length (Feet)	Skid Width (Feet)	Skid Height (Inches)
27845572-MB	16'	Unit	750	18"	3.9	20.5
		Bundle	25	non-skid	non-skid	non-skid

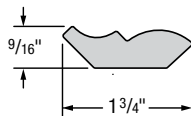

Trim Board measurements are nominal. All Sheet and 5/8" Trim Board measurements are actual. Please see our website for more detailed information.

Drip Cap

Item Number	Length	Selling UOM	Pieces/ Selling Unit	Skid Length (Feet)	Skid Width (Feet)	Skid Height (Inches)
27845580-MB	16'	Unit	660	20"	3.9	20.5
		Bundle	20	non-skid	non-skid	non-skid

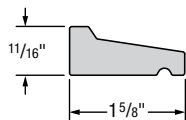

Rake Mould

Item Number	Length	Selling UOM	Pieces/ Selling Unit	Skid Length (Feet)	Skid Width (Feet)	Skid Height (Inches)
27845582-MB	16'	Unit	270	18"	3.9	20.5
		Bundle	10	non-skid	non-skid	non-skid

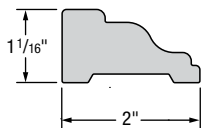

Panel Moulding

Item Number	Length	Selling UOM	Pieces/ Selling Unit	Skid Length (Feet)	Skid Width (Feet)	Skid Height (Inches)
27845595-MB	16'	Unit	672	18"	3.9	20.5
		Bundle	24	non-skid	non-skid	non-skid

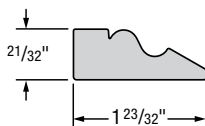

Shingle Mould

Item Number	Length	Selling UOM	Pieces/ Selling Unit	Skid Length (Feet)	Skid Width (Feet)	Skid Height (Inches)
27845585-MB	16'	Unit	480	18"	3.9	20.5
		Bundle	20	non-skid	non-skid	non-skid

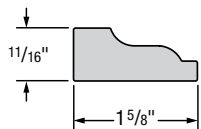

Quarter Round

Item Number	Length	Selling UOM	Pieces/ Selling Unit	Skid Length (Feet)	Skid Width (Feet)	Skid Height (Inches)
27845581-MB	16'	Unit	600	18"	3.9	20.5
		Bundle	25	non-skid	non-skid	non-skid

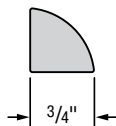

Trim Board measurements are nominal. All Sheet and 5/8" Trim Board measurements are actual. Please see our website for more detailed information.

BUILDREADY/MOULDINGS

Scotia Cove

Item Number	Length	Selling UOM	Pieces/Selling Unit	Skid Length (Feet)	Skid Width (Feet)	Skid Height (Inches)
27845583-MB	16'	Unit	600	18"	3.9	20.5
		Bundle	25	non-skid	non-skid	non-skid

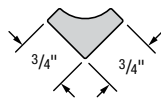

3X Crown

Item Number	Length	Selling UOM	Pieces/Selling Unit	Skid Length (Feet)	Skid Width (Feet)	Skid Height (Inches)
27845586-MB	16'	Unit	420	18"	3.9	20.5
		Bundle	10	non-skid	non-skid	non-skid

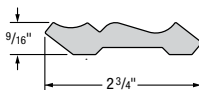

4X Crown

Item Number	Length	Selling UOM	Pieces/Selling Unit	Skid Length (Feet)	Skid Width (Feet)	Skid Height (Inches)
27845576-MB	16'	Unit	330	18"	3.9	20.5
		Bundle	10	non-skid	non-skid	non-skid

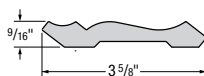

5X Crown

Item Number	Length	Selling UOM	Pieces/Selling Unit	Skid Length (Feet)	Skid Width (Feet)	Skid Height (Inches)
27845577-MB	16'	Unit	128	18"	3.9	20.5
		Bundle	4	non-skid	non-skid	non-skid

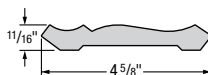

6X Crown

Item Number	Length	Selling UOM	Pieces/Selling Unit	Skid Length (Feet)	Skid Width (Feet)	Skid Height (Inches)
27845578-MB	16'	Unit	168	18"	3.9	20.5
		Bundle	6	non-skid	non-skid	non-skid

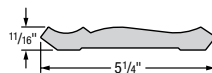

Trim Board measurements are nominal. All Sheet and 5/8" Trim Board measurements are actual. Please see our website for more detailed information.

8X Crown

Item Number	Length	Selling UOM	Pieces/ Selling Unit	Skid Length (Feet)	Skid Width (Feet)	Skid Height (Inches)
27845601-MB	16'	Unit	98	18"	3.9	20.5
		Bundle	2	non-skid	non-skid	non-skid

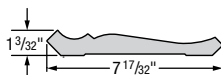

Rams Crown

Item Number	Length	Selling UOM	Pieces/ Selling Unit	Skid Length (Feet)	Skid Width (Feet)	Skid Height (Inches)
27845579-MB	16'	Unit	180	18"	3.9	20.5
		Bundle	6	non-skid	non-skid	non-skid

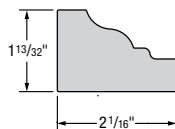

Imperial Rake Crown

Item Number	Length	Selling UOM	Pieces/ Selling Unit	Skid Length (Feet)	Skid Width (Feet)	Skid Height (Inches)
27845596-MB	16'	Unit	240	18"	3.9	20.5
		Bundle	8	non-skid	non-skid	non-skid

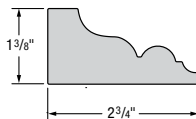

Solid Crown

Item Number	Length	Selling UOM	Pieces/ Selling Unit	Skid Length (Feet)	Skid Width (Feet)	Skid Height (Inches)
27845597-MB	16'	Unit	280	18"	3.9	20.5
		Bundle	8	non-skid	non-skid	non-skid

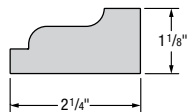

Pediment

Item Number	Length	Selling UOM	Pieces/ Selling Unit	Skid Length (Feet)	Skid Width (Feet)	Skid Height (Inches)
27845598-MB	12'	Unit	168	18"	3.9	20.5
		Bundle	4	non-skid	non-skid	non-skid

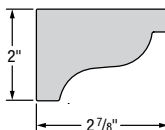

Trim Board measurements are nominal. All Sheet and 5/8" Trim Board measurements are actual. Please see our website for more detailed information.

BUILDREADY/MOULDINGS

Back Band

Item Number	Length	Selling UOM	Pieces/Selling Unit	Skid Length (Feet)	Skid Width (Feet)	Skid Height (Inches)
27845590-MB	16'	Unit	280	18"	3.9	20.5
		Bundle	10	non-skid	non-skid	non-skid

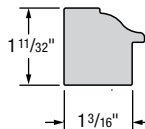

Adams Casing

Item Number	Length	Selling UOM	Pieces/Selling Unit	Skid Length (Feet)	Skid Width (Feet)	Skid Height (Inches)
27845594-MB	16'	Unit	180	18"	3.9	20.5
		Bundle	6	non-skid	non-skid	non-skid

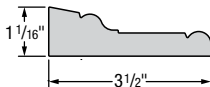

Water Table

Item Number	Length	Selling UOM	Pieces/Selling Unit	Skid Length (Feet)	Skid Width (Feet)	Skid Height (Inches)
27845599-MB	18'	Unit	216	18"	3.9	20.5
		Bundle	4	non-skid	non-skid	non-skid

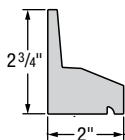

1-1/2" Square

Item Number	Length	Selling UOM	Pieces/Selling Unit	Skid Length (Feet)	Skid Width (Feet)	Skid Height (Inches)
27845587-MB	16'	Unit	304	18"	3.9	20.5
		Bundle	4	non-skid	non-skid	non-skid

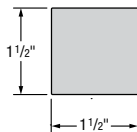

Sub Sill Nose

Item Number	Length	Selling UOM	Pieces/Selling Unit	Skid Length (Feet)	Skid Width (Feet)	Skid Height (Inches)
27845591-MB	16'	Unit	360	18"	3.9	20.5
		Bundle	12	non-skid	non-skid	non-skid

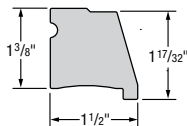

Trim Board measurements are nominal. All Sheet and 5/8" Trim Board measurements are actual. Please see our website for more detailed information.

Historic Sill

Item Number	Length	Selling UOM	Pieces/Selling Unit	Skid Length (Feet)	Skid Width (Feet)	Skid Height (Inches)
27845584-MB	16'	Unit	144	18"	3.9	20.5
		Bundle	4	non-skid	non-skid	non-skid

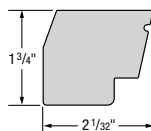

Window Sill Nose

Item Number	Length	Selling UOM	Pieces/Selling Unit	Skid Length (Feet)	Skid Width (Feet)	Skid Height (Inches)
27845592-MB	12'	Unit	270	18"	3.9	20.5
		Bundle	9	non-skid	non-skid	non-skid

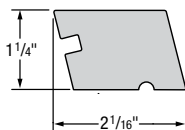

Large Sill Nose

Item Number	Length	Selling UOM	Pieces/Selling Unit	Skid Length (Feet)	Skid Width (Feet)	Skid Height (Inches)
27845593-MB	16'	Unit	180	18"	3.9	20.5
		Bundle	4	non-skid	non-skid	non-skid

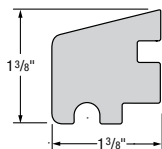

Window Sill

Item Number	Length	Selling UOM	Pieces/Selling Unit	Skid Length (Feet)	Skid Width (Feet)	Skid Height (Inches)
27845602-MB	12'	Unit	84	18"	3.9	20.5
		Bundle	4	non-skid	non-skid	non-skid

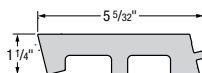

DESIGNREADY/TRIM

5/8

Trim Board
(5/8" actual)

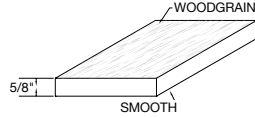
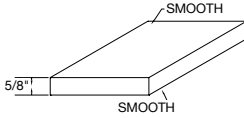

18" Lengths	Smooth	Woodgrain	Selling UOM	Pieces/ Selling Unit	Skid Length (Feet)	Skid Width (Feet)	Skid Height (Inches)
5/8" x 4	27885001	27887001	Unit	130	18	4	11.5
5/8" x 6	27885002	27887002	Unit	80	18	4	11.5
5/8" x 8	27885003	27887003	Unit	60	18	4	11.5
5/8" x 10	27885004	27887004	Unit	50	18	4	11.5
5/8" x 12	27885005	27887005	Unit	40	18	4	11.5
5/8" x 16	27885078	27887078	Unit	30	18	4	11.5

4/4

Trim Board
(3/4" actual)

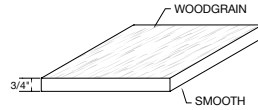
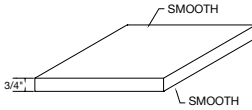

12' Offering	Smooth	Woodgrain	Selling UOM	Pieces/ Selling Unit	Skid Length (Feet)	Skid Width (Feet)	Skid Height (Inches)
1 x 4	27885146	27887146	Unit	104	12	4	11.1
1 x 6	27885147	27887147	Unit	64	12	4	11.1
1 x 8	27885148	27887148	Unit	48	12	4	11.1
1 x 10	27885149	27887149	Unit	40	12	4	11.1
1 x 12	27885150	27887150	Unit	32	12	4	11.1

18' Offering	Smooth	Woodgrain	Selling UOM	Pieces/ Selling Unit	Skid Length (Feet)	Skid Width (Feet)	Skid Height (Inches)
1 x 4	27885006	27887006	Unit	104	18	4	11.1
1 x 6	27885009	27887009	Unit	64	18	4	11.1
1 x 8	27885010	27887010	Unit	48	18	4	11.1
1 x 10	27885011	27887011	Unit	40	18	4	11.1
1 x 12	27885012	27887012	Unit	32	18	4	11.1
1 x 16	27885377	27887377	Unit	24	18	4	11.1

20' Offering	Smooth	Woodgrain	Selling UOM	Pieces/ Selling Unit	Skid Length (Feet)	Skid Width (Feet)	Skid Height (Inches)
1 x 3	27885519	27887519	Unit	114	20	4	9.6
1 x 4	27885513	27887513	Unit	104	20	4	11.1
1 x 6	27885514	27887514	Unit	64	20	4	11.1
1 x 8	27885515	27887515	Unit	48	20	4	11.1
1 x 10	27885516	27887516	Unit	40	20	4	11.1
1 x 12	27885517	27887517	Unit	32	20	4	11.1
1 x 16	27885518	27887518	Unit	24	20	4	11.1

Trim Board measurements are nominal. All Sheet and 5/8" Trim Board measurements are actual. Please see our website for more detailed information.

5/4
Trim Board
(1" actual)

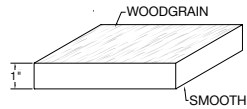
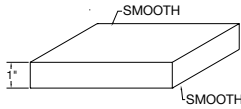

12" Offering	Smooth	Woodgrain	Selling UOM	Pieces/ Selling Unit	Skid Length (Feet)	Skid Width (Feet)	Skid Height (Inches)
5/4 x 4	27885156	27887156	Unit	78	12	4	11
5/4 x 6	27885157	27887157	Unit	48	12	4	11
5/4 x 8	27885158	27887158	Unit	36	12	4	11
5/4 x 10	27885187	27887187	Unit	30	12	4	11
5/4 x 12	27885208	27887208	Unit	24	12	4	11

18" Offering	Smooth	Woodgrain	Selling UOM	Pieces/ Selling Unit	Skid Length (Feet)	Skid Width (Feet)	Skid Height (Inches)
5/4 x 4	27885013	27887013	Unit	78	18	4	11
5/4 x 5	27885015	27887015	Unit	48	18	4	11
5/4 x 6	27885016	27887016	Unit	36	18	4	11
5/4 x 8	27885017	27887017	Unit	30	18	4	11
5/4 x 10	27885018	27887018	Unit	24	18	4	11
5/4 x 12	27885527	27887527	Unit	18	18	4	11
5/4 x 16	27845527	27848527	Unit	18	18	4	11

20" Offering	Smooth	Woodgrain	Selling UOM	Pieces/ Selling Unit	Skid Length (Feet)	Skid Width (Feet)	Skid Height (Inches)
5/4 x 4	27885072	27887072	Unit	78	20	4	11
5/4 x 6	27885074	27887074	Unit	48	20	4	11
5/4 x 8	27885075	27887075	Unit	36	20	4	11
5/4 x 10	27885076	27887076	Unit	30	20	4	11
5/4 x 12	27885077	27887077	Unit	24	20	4	11
5/4 x 16	27885405	27887405	Unit	18	20	4	11

5/4
Trim Board
(1" actual)

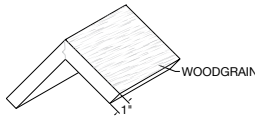

20" Offering	Woodgrain	Selling UOM	Pieces/ Selling Unit	Skid Length (Feet)	Skid Width (Feet)	Skid Height (Inches)
4 x 4	27887117-P	Units	48	20	4	19.25
		PlyPak	1	20	4	
6 x 6	27887118-P	Unit	32	20	4	27.25
		PlyPak	1	20	4	

Note: PlyPaks contain multiple pieces shrink wrapped for easy handling and protection from dirt and marks. Corners do not have film or sealed edges.

**BENDING
PVC TRIM**



Trim Board measurements are nominal. All Sheet and 5/8" Trim Board measurements are actual. Please see our website for more detailed information.

DESIGNREADY/TRIM

Sheet

(All measurements actual)

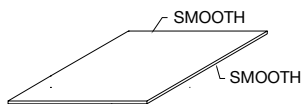

4' Wide & 8' Lengths	Smooth	Selling UOM	Pieces/Selling Unit	Skid Length (Feet)	Skid Width (Feet)	Skid Height (Inches)
3/8" Sheet	27885080	Unit	30	8	4	16.5
1/2" Sheet	27885037	Unit	25	8	4	17.8
5/8" Sheet	27885039	Unit	25	8	4	20.9
3/4" Sheet	27885042	Unit	20	8	4	20.3
1" Sheet	27885046	Unit	20	8	4	25.3

4' Wide & 10' Lengths	Smooth	Selling UOM	Pieces/Selling Unit	Skid Length (Feet)	Skid Width (Feet)	Skid Height (Inches)
3/8" Sheet	27885081	Unit	30	10	4	16.5
1/2" Sheet	27885038	Unit	25	10	4	17.8
5/8" Sheet	27885040	Unit	25	10	4	20.9
3/4" Sheet	27885043	Unit	20	10	4	20.3
1" Sheet	27885047	Unit	20	10	4	25.3

4' Wide & 12' Lengths	Smooth	Selling UOM	Pieces/Selling Unit	Skid Length (Feet)	Skid Width (Feet)	Skid Height (Inches)
3/8" Sheet	27885165	Unit	30	12	4	16.5
1/2" Sheet	27885229	Unit	25	12	4	17.8
5/8" Sheet	27885159	Unit	25	12	4	20.9
3/4" Sheet	27885044	Unit	20	12	4	20.3
1" Sheet	27885048	Unit	20	12	4	25.3

4' Wide & 18' Lengths	Smooth	Selling UOM	Pieces/Selling Unit	Skid Length (Feet)	Skid Width (Feet)	Skid Height (Inches)
3/8" Sheet	27885138	Unit	30	18	4	16.5
1/2" Sheet	27885400	Unit	25	18	4	17.8
5/8" Sheet	27885041	Unit	20	18	4	17.8
3/4" Sheet	27885045	Unit	18	18	4	18.8
1" Sheet	27885401	Unit	12	18	4	17.3



**INSTALLING
PVC TRIM**

Variform Vinyl Siding and Soffit products meet or exceed the following industry Standards and/or Building Code Approvals.

Standards and Codes	Report #
ASTM	C1363
ASTM	C272
ASTM	D2843 [U.B.C. #52-2]
ASTM	D3679
ASTM	D4226
ASTM	D4477
ASTM	D635
ASTM	E84
ASTM	E96
ICC Evaluation Service	NER-638
Metro Dade	08-0429.11
State of Florida	5538-R1
State of Florida	11191
State of Florida	5544
State of Florida	12141
Texas State Board of Insurance Ruling	EC-27

Compound Cell Classification: Variform Polyvinyl Chloride (PVC) compound is defined as 13344-B in conformance to ASTM D 1784 [1/8 inch Izod specimen].

Weathering: Environmental exposure testing conducted in three environments; dry, hot climate [Arizona], hot, humid climate [Florida] and northern temperate climate per ASTM D 3679.

Color Monitoring: Lot-to-lot color monitoring conducted by Spectrophotometer per Standard Test Procedure CQA332Q3.

Lock: Precision formed using post formed technique.

Product specifications are accurate as of the printing date of this specification sheet.

VSI Fire Statement: Rigid vinyl siding is made from organic materials and will melt or burn when exposed to a significant source of flame or heat. Building owners, occupants and outside maintenance personnel should always take normal precautions to keep sources of fire, such as barbecues and combustible materials, such as dry leaves, mulch and trash, away from vinyl siding. The Variform research and development team has developed a proprietary revolutionary technology - PermaHue®.

For a complete listing of certified products and information about the fire properties of vinyl siding, contact the Vinyl Siding Institute, 1201 15th St. NW, Suite 220, Washington, D.C., 20005 or visit the VSI website at www.vinylsiding.org for a current listing of certified products and colors.

PHYSICAL PROPERTIES

Extruded Polyvinyl Chloride (PVC) consisting exclusively of PVC compound with the following typical properties:

Physical Properties	Variform Vinyl Siding & Soffit	ASTM Standard
Izod impact at 320F, [ft.lbf/in.]	1.9	0.65 min
Izod impact at 740F, [ft.lbf/in.]	3.3	2.4 min
Tensile strength, [psi]	6,326	5,800
Tensile modulus, [psi]	364,500	319,000 min
Heat deflection Temp., [OF] @ 264 psi	167	158 min
Coefficient of linear thermal expansion	3.3x10-5	4.5x10-5 max
Shore D hardness	82	n/a
Chemical resistance properties	Excellent	n/a
Flame spread index	20.0	25.0
Smoke density developed	275	n/a

Compliance

Variform vinyl siding is listed in the National Evaluation Report-460. N.E.R.-460 and is recognized by SBCCI [Southern Builders Code Congress International], ICBO [International Conference of Building Officials] and BOCA [Building Officials and Code Administrators International].

Variform Vinyl Siding and Soffit is in conformance with ASTM D 3679, "Standard Specification for Rigid Polyvinyl Chloride [PVC] Siding."



*Consult the VSI website at www.vinylsiding.org for a current listing of certified products and colors.

PHYSICAL PROPERTIES

Injection Molded Painted Polypropylene

Physical Properties	Variform Shingle Siding	ASTM Standard
Panel color-thru	Yes	
Panel coating	None, Paint (variegated colors)	
Caliper of face	.101	
Caliper of nail hem between slots	.127	
Gloss	10	
Manufacturing physicals	Injection Molded Polypropylene	
Wind load test [-100PSF]	195 m.p.h.	D5206-096
Impact test [ft.-Lbs./in.]	1.0	D 250
Tensile strength [PSI]	2,900	D 638
Modules of elasticity [PSI]	340,000	
Deflection Temp. under flexural load [OF]	202	D648
Linear thermal expansion	1/16" per 300F	D698
Flame spread index	95	E 84-84

PHYSICAL PROPERTIES

Coated Aluminum Physical Characteristics and Manufacturing Data

Physical Properties

Acrylic Aluminum Products

Coating	Premium painted finish
Gloss	10-14 @ 600, ASTM D 523-80
Flexibility	No removal of finish with 600 Scotch Tape on a 2T bend. NCCA 11-19
Pencil Hardness	HB-H Eagle Turquoise, NCCA 11-12
Adhesion	Excellent, ASTM D 3359-83
Impact	No visual cracking or finish release when subjected to impact in inch pounds equal to one and one half times the metal thickness. NCCA 11-6
Humidity Resistance	No loss of gloss, cracking or peeling after 3,000 hours @ 100% relative humidity. ASTM D 2247-86A
Salt Spray Resistance	No under-cutting of film from edges in excess of 1/16" or face blistering after 1,000 hours at 5% neutral salt spray. ASTM B 117-85
Exterior Exposure	a. Fade: Max. #5 after 10 years at 450 south Florida exposure after removal of external deposits. ASTM D 2244-85 b. Chalk: Max. #8 rating on all colors with the exception of white within 10 years at 450 south Florida. ASTM D 659-86
Dry Film Thickness	.75-.90 mils
Solvent Resistance	100+MEK rubs

Meets the performance requirements of AAMA 1402-86

Member



PHYSICAL PROPERTIES

Coated Aluminum Physical Characteristics and Manufacturing Data

Physical Properties	PVC Aluminum Products
Coating	Premium striated finish
Gloss	22-27 @ 600, ASTM D 523-80
Flexibility	No removal of finish with 600 Scotch Tape on a 2T bend. NCCA 11-19
Pencil Hardness	2B Eagle Turquoise, NCCA 11-12
Adhesion	Excellent, ASTM D 3359-83
Impact	No visual cracking or finish release when subjected to impact in inch pounds equal to one and one half times the metal thickness. NCCA 11-6
Humidity Resistance	No loss of gloss, cracking or peeling after 3,000 hours @ 100% relative humidity. ASTM D 2247-86A
Salt Spray Resistance	No under-cutting of film from edges in excess of 1/16" or face blistering after 1,000 hours at 5% neutral salt spray. ASTM B 117-85
Exterior Exposure	a. Fade: Max. #5 after 10 years at 450 south Florida exposure after removal of external deposits. ASTM D 2244-85 b. Chalk: Max. #8 rating on all colors with the exception of white within 10 years at 450 south Florida. ASTM D 659-86
Dry Film Thickness	3.3-.3.7 mils
Solvent Resistance	MEK rubs none

Meets the performance requirements of AAMA 1402-86

PHYSICAL PROPERTIES

Coated Aluminum Physical Characteristics and Manufacturing Data

Physical Properties	DuraPro™ Aluminum Products
Coating	Textured satin finish
Gloss	20-40 @ 600, ASTM D 523-80
Flexibility	No removal of finish with 600 Scotch Tape on a 2T bend. NCCA 11-19
Pencil Hardness	HB-H Eagle Turquoise, NCCA 11-12
Adhesion	Excellent, ASTM D 3359-83
Impact	No visual cracking or finish release when subjected to impact in inch pounds equal to one and one half times the metal thickness. NCCA 11-6
Humidity Resistance	No loss of gloss, cracking or peeling after 3,000 hours @ 100% relative humidity. ASTM D 2247-86A
Salt Spray Resistance	No under-cutting of film from edges in excess of 1/16" or face blistering after 1,000 hours at 5% neutral salt spray. ASTM B 117-85
Exterior Exposure	a. Fade: Max. #5 after 10 years at 450 south Florida exposure after removal of external deposits. ASTM D 2244-85 b. Chalk: Max. #8 rating on all colors with the exception of white within 10 years at 450 south Florida. ASTM D 659-86
Dry Film Thickness	.70-.80 mils
Solvent Resistance	100+MEK rubs

Meets the performance requirements of AAMA 1402-86

MECHANICAL PROPERTIES

Material Specifications
Aluminum 3105

PROPERTIES

Tempor	Ultimate Tensile Strength (KSI)	Yield Tensile Strength (KSI)	Min Elong
H24	22-29	18 min	4.0
H26	25-32	21 min	2.0
H26P	26-34	22-29	2.0
H28P	28-34	25 min	2.0

Technical Specifications

Panels tested in accordance with ASTM D5206. Windspeed rating will vary depending on specific code region and construction method. Refer to local building codes for detailed requirements concerning allowable wind loads and specified conversion tables for actual windspeed.

Product Line	2024 IBC/IRC	
	Design Pressure Rating	Maximum Windspeed (Mph)
		ASD
Heritage Cedar Hand-Split Shingle	114	218
Heritage Cedar Perfection Shingle	105	209
Heritage Cedar Round-Cut Siding	68	168
Climaforce Insulated Siding	69	169
Board & Batten Siding	67	167
Vortex Extreme	64	163
Vortex Extreme Long Length	64	163
Camden Pointe	56	153
Beaded Siding	51	146
Ashton Heights	42	132
Beaded Soffit	42	132
D5 Premium Soffit/Vertical	42	132
Trivent High Performance Triple 3-1/3 Solid Soffit	42	132
American Herald	40	129
American Tradition	40	129
Contractor's Choice	40	129

Example wind velocity for 67 PSF is 180 MPH Zone B @ 30' building height.



LEADING WITH TECHNOLOGY TO SELL SIDING



The Home Design Visualizer uses the latest in technology to provide design inspiration and show home transformation. Simply scanning the QR code or visiting variform.renoworks.com gives contractors and homeowners the ability to quickly and easily find the right products for their project.



BUILD WITH CONFIDENCE

As part of the Pro Academy, Variform installers receive access to a suite of business-building tools, programs, and training materials, created to give you a smoother, more profitable building experience.

Available to you:

- > Training video library with over 45 videos created by a team of experts on product knowledge, installation techniques and more
- > Digital installation guide with language translation
- > Certification programs
- > Contractor Reward Program



Scan QR code or visit plygem.com/siding/for-siding-pros to learn more.

THE PLY GEM PORTFOLIO OF BRANDS



The Total Designed Exterior

Ply Gem Brands and Solutions deliver national coverage of the industry's most comprehensive portfolio of designed exterior products that are perfect for any job—and every home, as well as a full offering of solutions designed to support building professionals.



SIDING



WINDOWS



SHUTTERS



STONE VENEER



FENCE & RAILING



PATIO DOORS



TRIM & MOULDINGS



METAL & RAINWARE



ACCESSORIES



VARIFORM[®]

by  Ply Gem

For more than 50 years, the Variform brand of vinyl siding has set the standard for quality, durability and versatility on any jobsite.

With a legacy built on trust, Variform delivers not only effortless style but also proven performance that stands the test of time. Designed to ensure easy installation and upkeep. Variform products provide peace of mind to homeowners and professionals alike, allowing them to aspire to the next level of excellence with confidence.

Variform. Siding that withstands.



Cornerstone Building Brands, Inc., reserves the right to alter, modify or delete items from time to time without notice. Due to printing limitations, colors may not be exactly as shown. Contact your sales representative for actual product and color samples. Variform, and the Variform logo are trademarks of Variform, Inc. *Consult the VSI Website at vinylsiding.org for current list of certified products and colors.

VARIFORM.COM | (888) 9-PLYGEM
5020 Weston Parkway, Cary, NC 27513

© 2025 Variform, Inc., part of **Cornerstone Building Brands, Inc.** ALL RIGHTS RESERVED.

3301079991113/9201079991113/RevO/MS/IMG/1025



PART OF THE CORNERSTONE BUILDING BRANDS FAMILY